

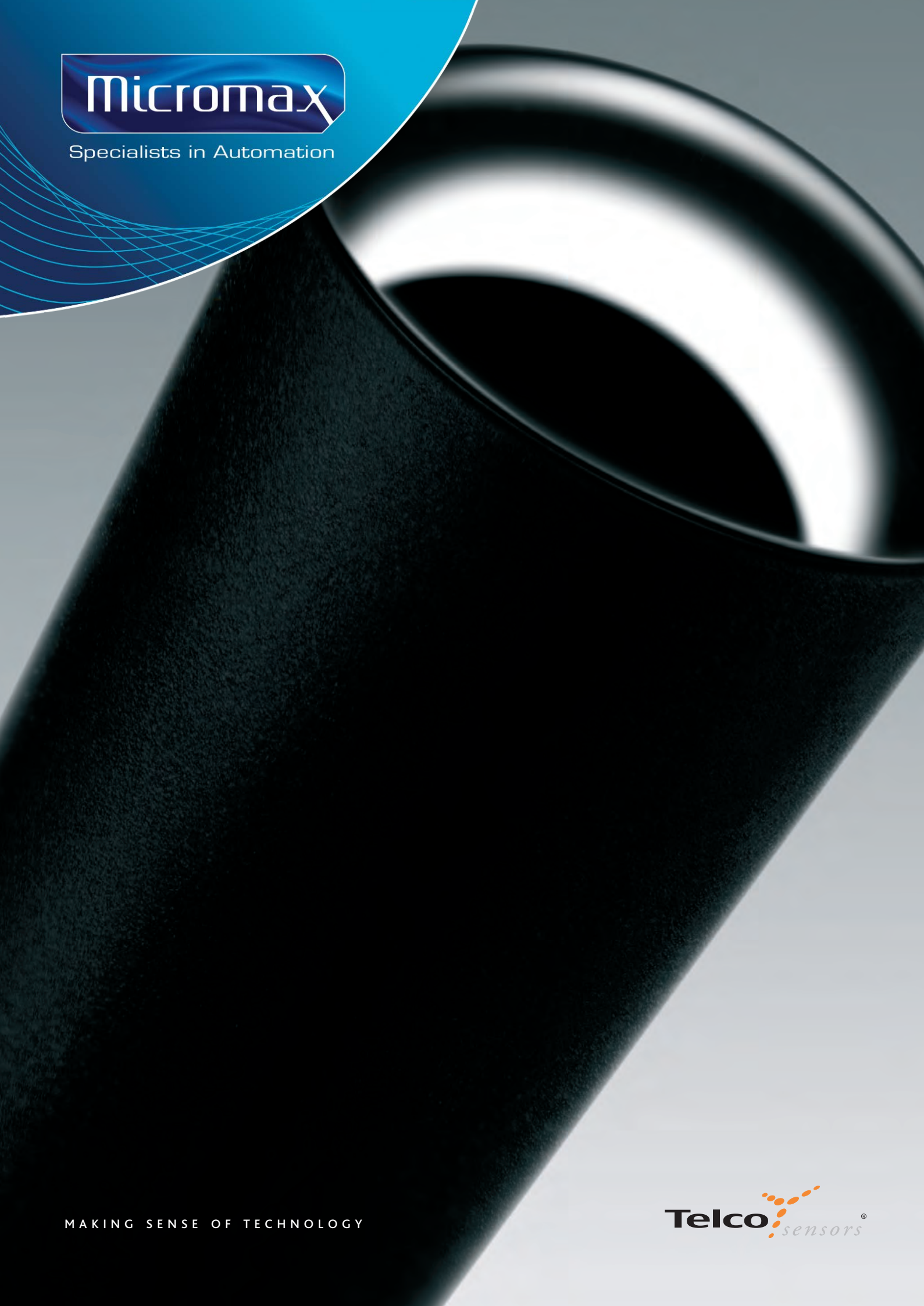

Specialists in Automation



MAKING SENSE OF TECHNOLOGY



MAKING SENSE OF TECHNOLOGY

TABLE OF CONTENTS

Corporate Profile	Corporate Profile	2
	Telco's 5 Core Values	8
Remote Photoelectric Systems	Remote Sensor Series	
	Remote Sensors	13
	Photoelectric Amplifier Series	
	PA 01	23
	PA 10	25
	PA 11	27
	PA 15	29
	Multiplexed Amplifier Series	
	MPA 21	35
	MPA 41	37
	MPA 81	41
	Photoelectric Amplifier Bus Series	
	PAB 10	49
	PAB 20	53
	PAB 30	57
	PPB 00	61
Self-Contained Photoelectric Systems	SpaceMaster™ Series	
	SM 3000	67
	SM 6000	73
	SM 7000	79
	SM 8000	85
	SM 9000	91
	SpacePak™ Series	
	SP 2000	99
Self-Contained Light Curtain Systems	SpaceGuard™ Series	
	SG 1	109
	SG 2	117
	SG 10	121
	SG 14	127
	SGC 1	133
Remote Light Curtain Systems	SpaceGuard™ Series	
	SG 11	135
	SGC 11	141
Optical Fork Sensor Systems	Optical Fork Sensor Series	
	OFS	145
Accessories	PP 00	151
	Glass Fibre Optics	153
	Mounting Brackets	157
	Apertures & Adaptors	158
	Reflectors	159
	Sockets & Connectors	160
	Cables	161
Complimentary Products	OAS	163
Applications	Applications	166
Glossary & References	Terms	176
	Operation Modes	178
	Reference Tables	179

HOW THE STORY BEGAN

Telco has come a long way since its humble beginnings in Denmark in 1975, but during all those years we have never lost focus of the core competences that have made Telco a success. We started with a new idea, which was to design and produce sensors, both simple and versatile in design, which would work in the most challenging conditions and endure the most hostile environments imaginable.

We turned this concept into a success with strong business acumen and a firm commitment to pursue the original idea with confidence and without compromise. We have remained true to this concept and continued to seek new and different ways to offer reliable sensing solutions in applications not thought possible before. This has been stimulated by our curiosity and quest to question the ordinary.

The experience and knowledge gained over the years has taken us into new industrial fields, and this has allowed us to expand our sensing solutions and develop into the sensor specialist that we are today.

A REPUTATION BUILT ON QUALITY

All Telco's products are designed, developed and manufactured in Denmark in our state-of-the-art production facilities. Dedicated and skilled employees together with advanced automated production equipment and machinery ensures that all Telco's products not only meet, but surpass the high quality standards set by Telco that have become widely acknowledged in the industry. Telco's total quality management guarantees that the raw materials, components and the finished products have undergone comprehensive quality inspections at each production stage, achieving unmatched technical superiority.

The craftsmanship of our employees together with the flexibility of our workgroups, enable us to efficiently produce and reliably deliver the thousands of different product types that Telco offers today. But above all, Telco has never just settled. Investments in the latest production machinery are continually made and the workforce is trained on a regular basis in order to maintain, and moreover, better the quality and efficiency – in line with current international standards and regulations.







TELCO'S ICONIC SENSORS

Telco has become one of the most sought-after, high performance optical sensor manufacturers in the world. The Telco products are globally recognised as the only sensors that will work in sites where most others fail. Our sensors function relentlessly and reliably in almost any condition.

They have to because that's what has come to be expected from Telco and besides – people rely on them. We believe we have narrowed the development of sensor systems down to a fine art – nevertheless we are still endlessly striving to discover ways to apply new sensor technologies and designs to our products.

It is fair to say that Telco's global success is the result of many years listening to the experts, our customers, who we consider to be our close partners and they have influenced and inspired the design of our unique and high-performing sensor products.



THE FINE ART OF DEVELOPMENT

Our R&D facilities in Denmark consist of a group of dedicated, experienced and creative engineers whose curiosity and aspirations are motivated by keeping ahead of new customer demands and new market developments. The latest in sophisticated instruments and software are utilised in the development process and test procedures, which are carried-out in Telco's own specialised laboratories. Each individual project design is subjected to Telco's rigorous environmental tests that assure the Telco standard in quality, reliability and performance is met.

The creative hands and minds of our dynamic department has enabled Telco to design individually customised sensor solutions for the Original Equipment Manufacturer (OEM) whose needs exceed the ordinary. Telco's ability and experience of efficiently translating customer requirements and wishes into a working sensor system, has been the key to successful product customisation.





SERVICE TO MATCH A QUALITY PRODUCT

The Telco Team network spans the globe across six continents, making our world a very small place and our local presence, strong. Our Telco Teams provide 24 hours-a-day and 7 days-a-week service, ensuring fast and reliable delivery – wherever and whenever. At Telco, we devote a lot of time to training our Telco Teams and sales subsidiaries, whose sales engineers provide our customers with day-to-day service and technical assistance.

Working closely with the Teams guarantees that the Telco philosophy of commitment and service are delivered to our customers globally. The knowledge and experience, obtained over the many years by Telco and our Teams, from the thousands of different industries and applications where the Telco products are successfully installed, ensures that our service offers a professional level of on-site support and application know-how.

BREAKING BOUNDARIES

Telco continues to break boundaries and exceed limits, when it comes to where our optical sensors are successfully installed and used. The versatility of our sensors can easily be confirmed by the wide range of industries, where they are used for detecting, positioning, measuring, counting and sorting.

Some of these industries include: automatic doors, industrial doors and gates, elevators, carwash, sawmill and forestry, packaging, material handling, material processing, factory automation and controls, escalators, agriculture, access controls, fishery, food processing, pharmaceuticals, mining – and many others.

Our ambition and desire to see the Telco sensor systems installed and functioning in new locations is exciting, and it keeps the Telco network moving forward and seeking new ways to apply our sensor technology. More than 99% of Telco's output is exported world-wide and all the Telco products carry a 3-year world-wide warranty.

TELCO'S 5 CORE VALUES

When you choose a Telco product, you choose something more than just a sensor system. You choose an attitude towards reliability, durability and performance.

No Telco sensor has ever been created merely to just be good enough. All our sensors have inherited distinctive and fundamental values that make us different from the rest. These values have, and will continue to, ensure that our sensors work where others fail.

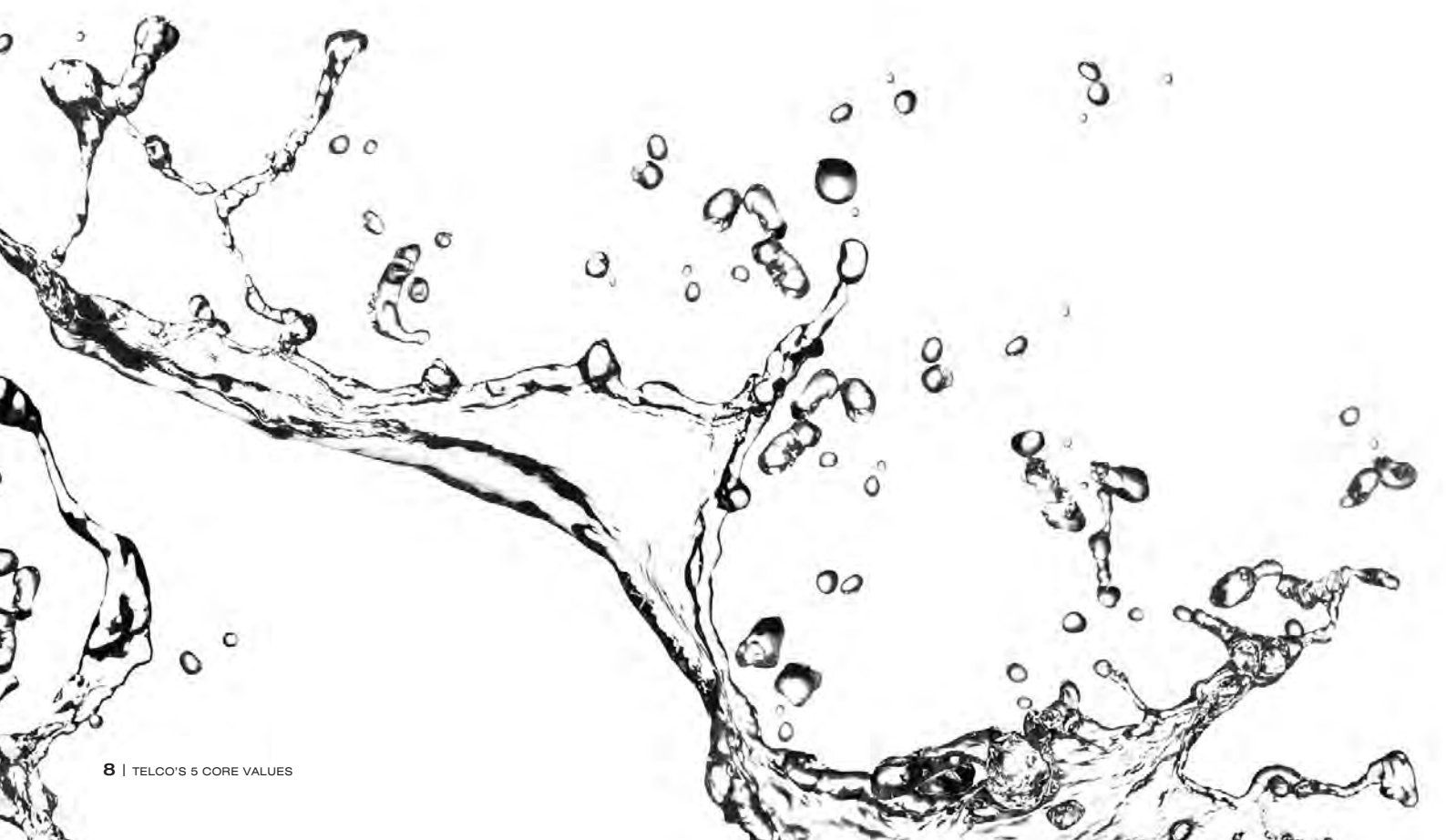

1 EASY INSTALLATION

Installing a Telco sensor is as easy as child's play. Our sensors are easy to align and require no complicated set-ups that guarantee effortless installation every time.



2 IMMUNITY TO LIGHT

No light will blind a Telco sensor. Our sensors do not need to be covered or hidden from ambient or extraneous light to function problem-free.

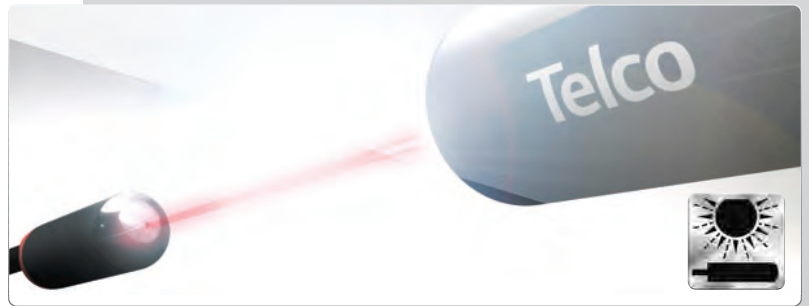

3 PENETRATION POWER

Severe contamination is no challenge for Telco's sensors. Our infrared sensors penetrate through any contamination thrown at them and will operate relentlessly even in the most hostile environments.



4 WATER RESISTANCE

Telco's sensors like it wet. Our sensors are designed to withstand direct exposure to water and high pressure spray and are capable of operating reliably in wet conditions.

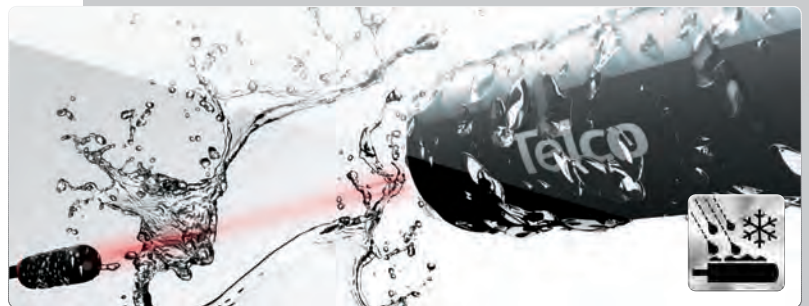

5 SHOCK & VIBRATION RESISTANCE

Nothing endures maltreatment like a Telco sensor. Our sensors can tolerate severe vibrations and physical impact without hindering lifetime or performance.





REMOTE SENSOR SERIES

Telco's remote sensor series can always be depended on to do the job. Although simple in design and modest in size, nothing performs more reliably in hostile environments and challenging conditions than these sensors. They may be commonly under-estimated, but it does not take long to realise that they are the most powerful and versatile infrared sensors in the industry.



REMOTE SENSOR SERIES

Description

- Operation mode and max sensing range:
Thru-beam: Dependent on amplifier (up to 70m)
Diffuse proximity: Dependent on amplifier (up to 5m)
- Optional sensor monitor LED
- Wide variety of housings
- High tolerance to hostile environments
- Cable or plug connections
- Available with optional  ATEX approval



The remote sensor series, which consists of a transmitter LT and receiver LR, is made to operate in conjunction with a Telco photoelectric amplifier from the PA, MPA or PAB programmes.

The remote sensors are available in a wide range of housings, with either cable or plug connection, and may be used in thru-beam or diffuse proximity mode.

The series is available with optional power-(LR) and output-(LT) monitor LEDs for use with any Telco photoelectric amplifier which has the sensor LED drive feature incorporated.

Technical Data

		LT	LR
Transmitter diode		Ga Al As, (880 nm)	-
Photo transistor		-	Silicon NPN
Housing material	Sensor housing	Refer to Available Types	
	Front lens	Polycarbonate	
Cable, PVC Ø 4,0 mm		2 x 0,25 mm ²	1 x 0,25 mm ² + shield
Min. cable bending radius		45 mm	

Environmental Data

Vibration		10-55 Hz, 0,5 mm
Shock		30 g
Light immunity, @ 20° incidence	101 Series	> 50 000 lux
	100 Series	> 80 000 lux
	110 / 120 Series	> 100 000 lux
Temperature, operation		-25 to +65 °C
Temperature, storage		-40 to +80 °C
Sealing class		IP 67
Approvals		CE

REMOTE SENSOR SERIES

Available Types

	Series	Optical Angle	Connection		5 m cable	15 m cable	3 pin, M8 plug	4 pin, M12 plug
			Housing Material	Housing Type				
Transmitter	101	+/- 10°	Polycarbonate	Ø10	LT 101 AP25 5	LT 101 AP25 15	LT 101 AP25 T3 ³	-
				M12 x 1	LT 101 TP25 5	LT 101 TP25 15	LT 101 TP25 T3 ³	-
			Nickel Plated Brass	M12 x 1	LT 101 TB25 5	LT 101 TB25 15	LT 101 TB25 T3 ³	-
					Stainless Steel (AISI 316)	LT 101 TS25 5	LT 101 TS25 15	LT 101 TS25 T3 ³
			Polyester	□ 9,5 x 11,5	LT 101 SG 5 ^{2,3}	LT 101 SG 15 ^{2,3}	LT 101 SG T3 ³	-
			ABS	Ø12,7 Snap	LT 101 S22 5 ^{2,3}	LT 101 S22 15 ^{2,3}	-	-
Receiver	101	+/- 6°	Polycarbonate	Ø10	LR 101 AP25 5	LR 101 AP25 15	LR 101 AP25 T3 ³	-
				M12 x 1	LR 101 TP25 5	LR 101 TP25 15	LR 101 TP25 T3 ³	-
			Nickel Plated Brass	M12 x 1	LR 101 TB25 5	LR 101 TB25 15	LR 101 TB25 T3 ³	-
					Stainless Steel (AISI 316)	LR 101 TS25 5	LR 101 TS25 15	LR 101 TS25 T3 ³
			Polyester	□ 9,5 x 11,5	LR 101 SG 5 ^{2,3}	LR 101 SG 15 ^{2,3}	LR 101 SG T3 ³	-
			ABS	Ø12,7 Snap	LR 101 S22 5 ^{2,3}	LR 101 S22 15 ^{2,3}	-	-

Transmitter	100	+/- 12° (High Power)	Polycarbonate	Ø10	LT 100H AP38 5	LT 100H AP38 15	LT 100H AP38 T3 ³	-
				M12 x 1	LT 100H TP38 5	LT 100H TP38 15	LT 100H TP38 T3 ³	-
			Nickel Plated Brass	M12 x 1	LT 100H TB38 5	LT 100H TB38 15	LT 100H TB38 T3 ³	LT 100H TB58 J ³
					Stainless Steel (AISI 316)	LT 100H TS38 5	LT 100H TS38 15	LT 100H TS38 T3 ³
			Polyester	□ 9,5 x 11,5	LT 100H SG 5 ^{2,3}	LT 100H SG 15 ^{2,3}	LT 100H SG T3 ³	-
		Polycarbonate	Ø12,7 Snap	LT 100H S30 5 ^{2,3}	LT 100H S30 15 ^{2,3}	-	-	
		+/- 6°	Polycarbonate	Ø10	LT 100 AP38 5	LT 100 AP38 15	LT 100 AP38 T3 ³	-
				M12 x 1	LT 100 TP38 5	LT 100 TP38 15	LT 100 TP38 T3 ³	-
			Nickel Plated Brass	M12 x 1	LT 100 TB38 5	LT 100 TB38 15	LT 100 TB38 T3 ³	LT 100 TB58 J ³
					Stainless Steel (AISI 316)	LT 100 TS38 5	LT 100 TS38 15	LT 100 TS38 T3 ³
Polyester	□ 9,5 x 11,5		LT 100 SG 5 ^{2,3}	LT 100 SG 15 ^{2,3}	LT 100 SG T3 ³	-		
Polycarbonate	Ø12,7 Snap	LT 100 S30 5 ^{2,3}	LT 100 S30 15 ^{2,3}	-	-			
Receiver	100	+/- 7°	Polycarbonate	Ø10	LR 100 AP38 5	LR 100 AP38 15	LR 100 AP38 T3 ³	-
				M12 x 1	LR 100 TP38 5	LR 100 TP38 15	LR 100 TP38 T3 ³	-
			Nickel Plated Brass	M12 x 1	LR 100 TB38 5	LR 100 TB38 15	LR 100 TB38 T3 ³	LR 100 TB58 J ³
					Stainless Steel (AISI 316)	LR 100 TS38 5	LR 100 TS38 15	LR 100 TS38 T3 ³
			Polyester	□ 9,5 x 11,5	LR 100 SG 5 ^{2,3}	LR 100 SG 15 ^{2,3}	LR 100 SG T3 ³	-
Polycarbonate	Ø12,7 Snap	LR 100 S30 5 ^{2,3}	LR 100 S30 15 ^{2,3}	-	-			

Transmitter	110	+/- 5°	Polycarbonate	Ø10	LT 110 AP38 5	LT 110 AP38 15	LT 110 AP38 T3 ³	-
				M12 x 1	LT 110 TP38 5	LT 110 TP38 15	LT 110 TP38 T3 ³	-
			Nickel Plated Brass	M12 x 1	LT 110 TB38 5	LT 110 TB38 15	LT 110 TB38 T3 ³	LT 110 TB58 J ³
Stainless Steel (AISI 316)	LT 110 TS38 5	LT 110 TS38 15	LT 110 TS38 T3 ³		LT 110 TS58 J ³			
Receiver	110	+/- 3°	Polycarbonate	Ø10	LR 110 AP38 5	LR 110 AP38 15	LR 110 AP38 T3 ³	-
				M12 x 1	LR 110 TP38 5	LR 110 TP38 15	LR 110 TP38 T3 ³	-
			Nickel Plated Brass	M12 x 1	LR 110 TB38 5	LR 110 TB38 15	LR 110 TB38 T3 ³	LR 110 TB58 J ³
Stainless Steel (AISI 316)	LR 110 TS38 5	LR 110 TS38 15			LR 110 TS38 T3 ³	LR 110 TS58 J ³		

Transmitter	120	+/- 4°	Nickel Plated Brass	M18 x 1	LT 120 TB45 5	LT 120 TB45 15	-	LT 120 TB45 J
Receiver		+/- 2,5°			LR 120 TB45 5	LR 120 TB45 15	-	LR 120 TB45 J

Note: 1. Photo amplifiers to be ordered separately.

2. Remote sensors are available with optional power (LR) and output (LT) monitor LEDs for use with the applicable Telco photoelectric amplifier, which has the sensor LED drive. Add 'L' after the series number for sensor monitor LED e.g. LT/LR 101L AP 25 5. Sensors marked ² are not available with this optional feature.

3. Remote Sensor series with cable connection is available to comply with ATEX  II 3 GD T6 EEx nA II U. Add "/EX" after the series number e.g. LT/LR 100/EX TS38 5. Sensors marked ³ are not available to comply with ATEX approval.

REMOTE SENSOR SERIES

Applicable Photoelectric Amplifiers and Maximum Ranges

Remote Sensor Series	101		100		110		120		
	Thru-beam	Diffuse Proximity	Thru-beam	Diffuse Proximity	Thru-beam	Diffuse Proximity	Thru-beam	Diffuse Proximity	
Photoelectric Amplifier Series									
PA 01	8 m	0,6 m	10 m	0,7 m	23 m	1,6 m	45 m	3,5 m	
PA 10	A	11 m	0,9 m	-	-	-	-	-	
	B	-	-	15 m	1,1 m	35 m	2,0 m	60 m	4,0 m
PA 11	-	-	18 m	1,3 m	40 m	2,7 m	70 m	5,0 m	
PA 15	-	-	18 m	1,3 m	40 m	2,7 m	70 m	5,0 m	
Multiplexed Amplifier Series									
MPA 21	-	-	10 m	0,7 m	25 m	1,6 m	45 m	3,5 m	
MPA 41	A/B	-	-	8 m	0,6 m	18 m	1,3 m	35 m	2,0 m
	C/D	-	-	4 m	0,4 m	9 m	0,7 m	18 m	1,3 m
MPA 81	A/B	-	-	8 m	0,6 m	18 m	1,3 m	35 m	2,0 m
	C/D	-	-	4 m	0,4 m	9 m	0,7 m	18 m	1,3 m
Photoelectric Amplifier Bus Series									
PAB 10	-	-	18 m	1,3 m	40 m	2,7 m	70 m	5,0 m	
PAB 20	-	-	12 m	0,8 m	27 m	1,7 m	47 m	3,6 m	
PAB 30	-	-	12 m	0,8 m	27 m	1,7 m	47 m	3,6 m	

Note: 1. Sensing range of LT 100H high power used in conjunction with the LR 100 increases range by 25% in 100 series sensing ranges
 2. Sensing ranges using glass fibre optics, please refer to page 155.

Connections

	Cable	M8 Plug / Cable	M12 Plug / Cable
Transmitter Signal	Red	Pin 1 / Brown	Pin 1 / Brown
Transmitter Ground	Black	Pin 3 / Blue	Pin 3 / Blue
Receiver Signal	Yellow	Pin 4 / Black	Pin 4 / Black
Receiver Ground	Shield	Pin 3 / Blue	Pin 3 / Blue

3 pin, M8

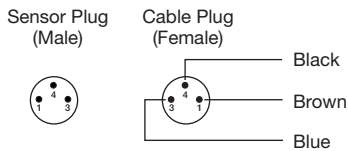

4 pin, M12

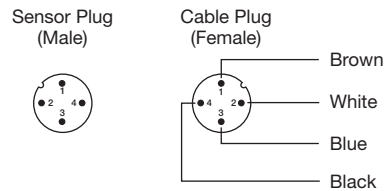

Refer to page 161 for extension cables

Wiring Diagrams

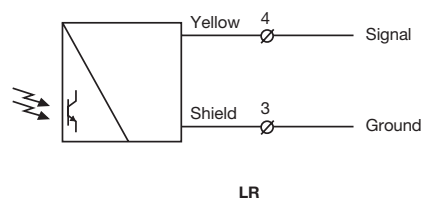
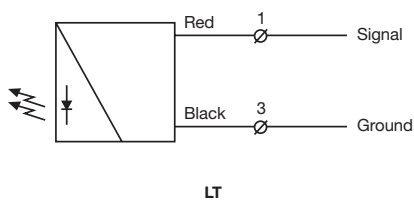

Dimensions and Descriptions

Series 101

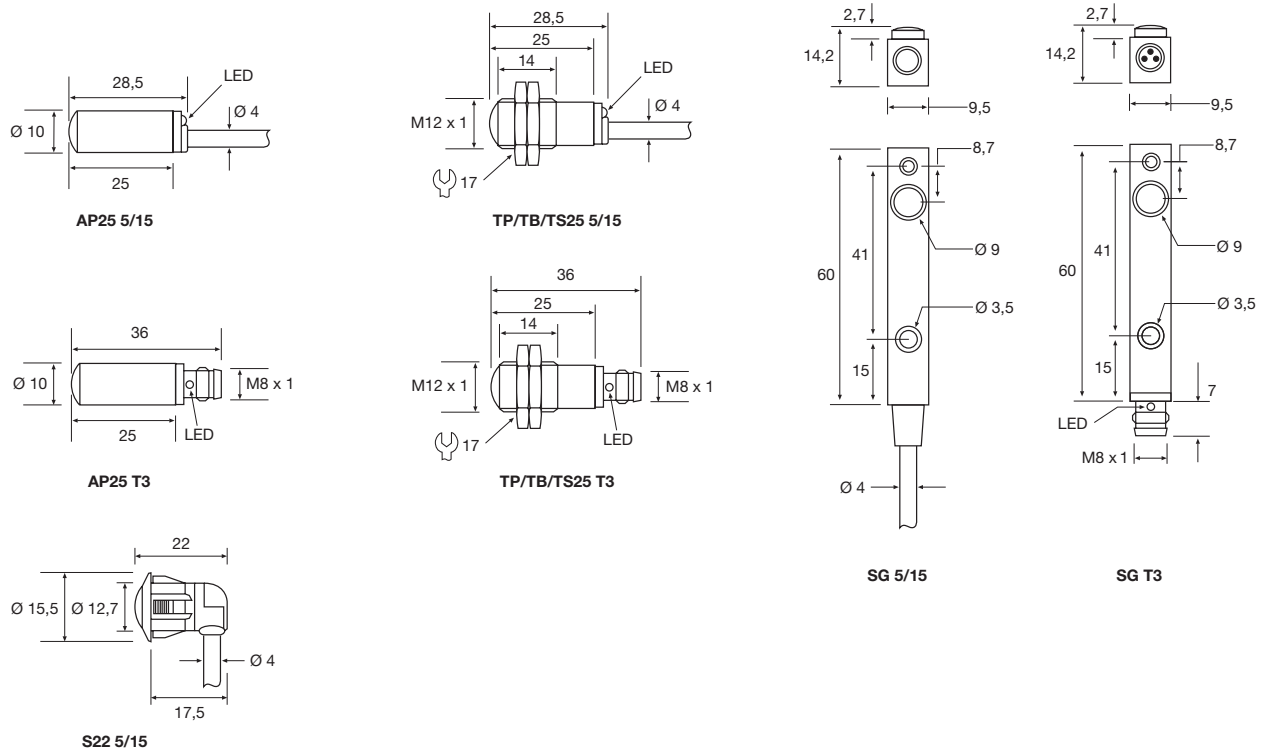

Series 100

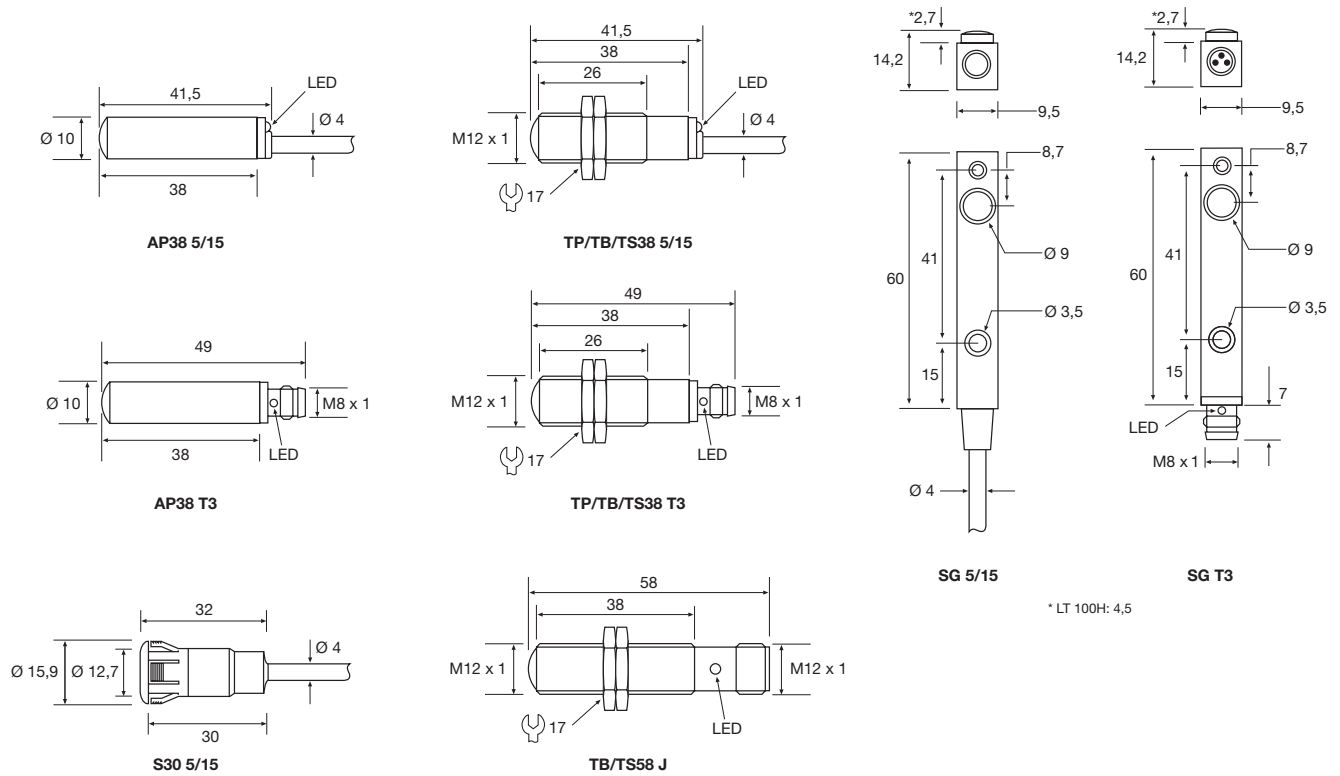

* LT 100H: 4,5

(Units in mm)

REMOTE SENSOR SERIES

Series 110

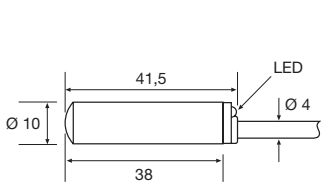

AP38 5/15

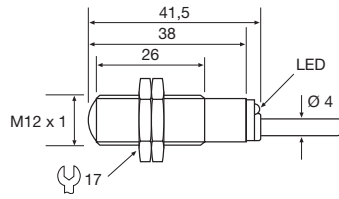

TP/TB/TS38 5/15

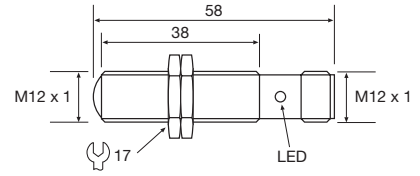

TB/TS58 J

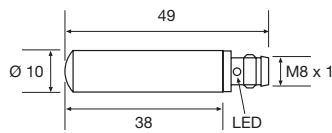

AP38 T3

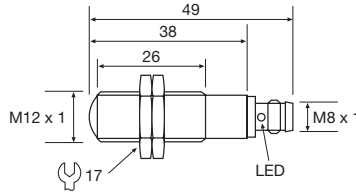

TP/TB/TS38 T3

Series 120

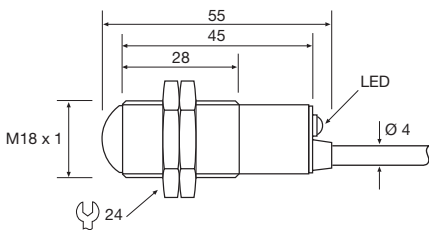

TB45 5/15

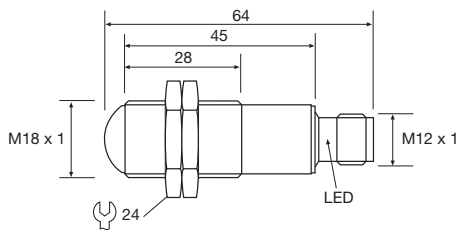

TB45 J

(Units in mm)

Sensing Characteristics

Parallel Displacement (Thru-beam)

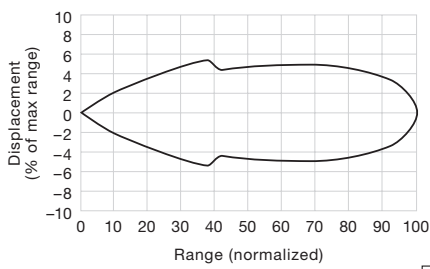

Series 101

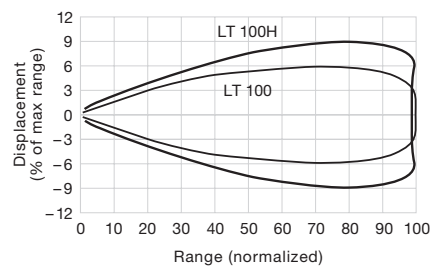
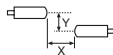

Series 100

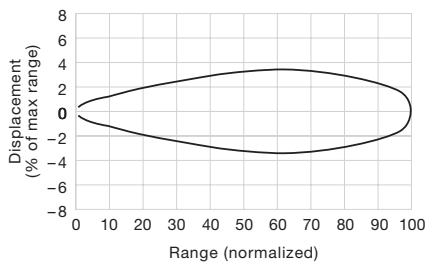
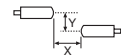

Series 110

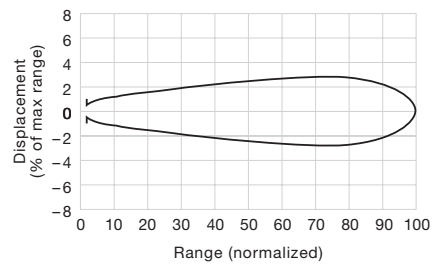
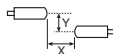

Series 120

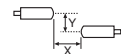

Sensing Characteristics

Angular Displacement (Thru-beam)

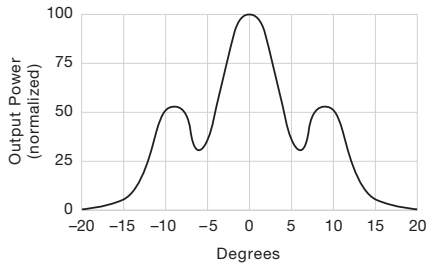

LT 101

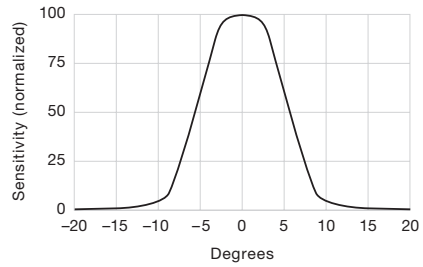

LR 101

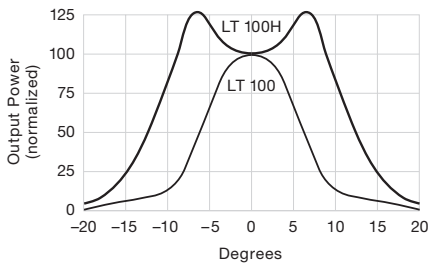

LT 100

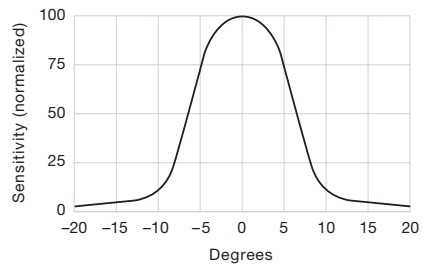

LR 100

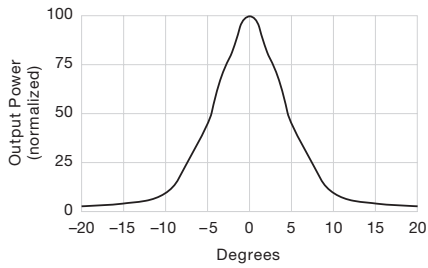

LT 110

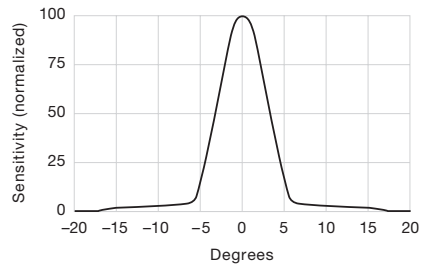

LR 110

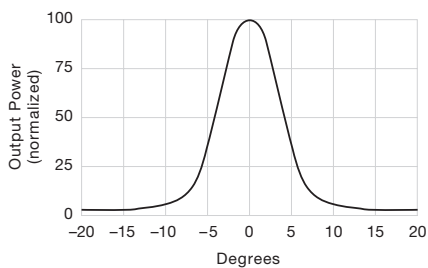

LT 120

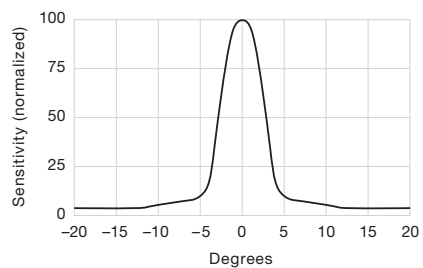

LR 120

Telco reserves the right to change specifications without notice.

PHOTOELECTRIC AMPLIFIER SERIES

Telco's photoelectric amplifier series performs as good today as it did when it first appeared almost 25 years ago. But while the simple design of this iconic product has remained the same in all that time, the technology on the inside has been constantly refined – so it continues to offer nothing less than the most reliable and powerful performance possible.



Description

- Operation mode and max sensing range:
Thru-beam: 0-45 m
Diffuse proximity: 0-3,5 m
- 230 V ac, 115 V ac or 24 V ac/dc supply voltage
- Automatic and/or manual sensitivity adjustment
- Sensor LED-drive
- Adjustable on/off time delay
- 1 relay or 1 transistor output
- STF – Signal Tracking Feature
- Switch selectable light or dark function
- Switch selectable long or short range
- Power, output and signal status indicators
- Test input
- 11-pole DIN socket connection



The PA 01 is a 1-channel photoelectric amplifier, which is to be used in conjunction with a set of remote transmitter LT and receiver LR from the series 101, 100, 110 or 120.

This amplifier series offers a choice between automatic and/or manual sensitivity adjustment with or without a 0-10 sec on/off time delay via integral potentiometers located on the front panel of the amplifier. Output can be selected from either a relay or an NPN/PNP transistor output. Light or dark function and long or short range are switch selectable.

In automatic mode, set up is required. This is achieved by pressing the teach-in button located on the front panel. This unique feature ensures

that the transmitting power level is adjusted according to the application, thus achieving optimal hysteresis and excess gain. Once set up, the system will automatically compensate for moderate misalignment and contamination during operation. In manual mode, the teach-in button allows for an overall manual system test by temporarily disabling the transmitter. The sensor LED drive powers the optional monitor LEDs available on the remote sensors – output (LT) and power (LR). The feature STF allows up to 3 identical systems to operate within a close distance of each other without optical cross talk as each system automatically maintains different transmitter frequencies.

Technical Data		
Supply voltage		115 V ac or 230 V ac
		12-30 V ac / 12-36 V dc
Voltage tolerance		+/- 15 %
Current consumption		Max. 2,5 VA
Output	Relay	1 open / 1 close, 230 V ac / 3 A, 120 V ac / 5 A
	Transistor	100 mA / 36 V dc
Alarm output		-
Power on indicator		Green LED
Output indicator		Yellow LED
Signal status indicator		Green LED
LR sensor failure indicator		-
LT sensor failure indicator		-
Sensor monitor LED drive		The green monitor LED on the receiver indicates 'Power ON' The yellow monitor LED on the transmitter indicates 'PA 01 output activated'
Hysteresis		Approx. 20 %
Operation frequency	Relay	11 Hz
	Transistor	14 Hz
Response time t _{ON} / t _{OFF}	Relay	45 ms / 45 ms
	Transistor	35 ms / 35 ms
Delay t _{ON} / t _{OFF}	PA 01 C	0-10 sec, adjustable
Housing material		Noryl

Environmental Data		
Temperature, operation		-10 to +55 °C
Temperature, storage		-40 to +80 °C
Sealing class		IP 40
Approvals		CE

Available Types

Model	Connection	Time Delay	Supply Voltage	12-30 V ac	115 V ac	230 V ac
			Output	Order Reference		
PA 01 A Automatic	11-pole DIN socket	-	Relay	PA 01 A 519	PA 01 A 511	PA 01 A 510
			NPN and PNP	PA 01 A 619	PA 01 A 611	PA 01 A 610
PA 01 B Automatic/Manual		-	Relay	PA 01 B 519	PA 01 B 511	PA 01 B 510
			NPN and PNP	PA 01 B 619	PA 01 B 611	PA 01 B 610
PA 01 C Automatic/Manual		On/Off delay	Relay	PA 01 C 519	PA 01 C 511	PA 01 C 510
			NPN and PNP	PA 01 C 619	PA 01 C 611	PA 01 C 610

Note: Remote sensors and 11-pole DIN socket to be ordered separately.

Applicable Remote Sensors and Ranges

Series	Thru-beam	Diffuse Proximity
101	8 m	0,6 m
100	10 m	0,7 m
110	23 m	1,6 m
120	45 m	3,5 m

Wiring Diagrams

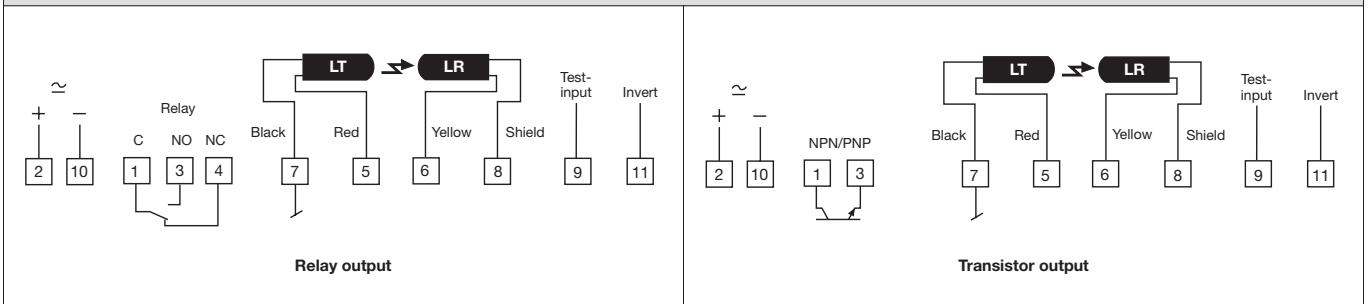

Dimensions and Descriptions

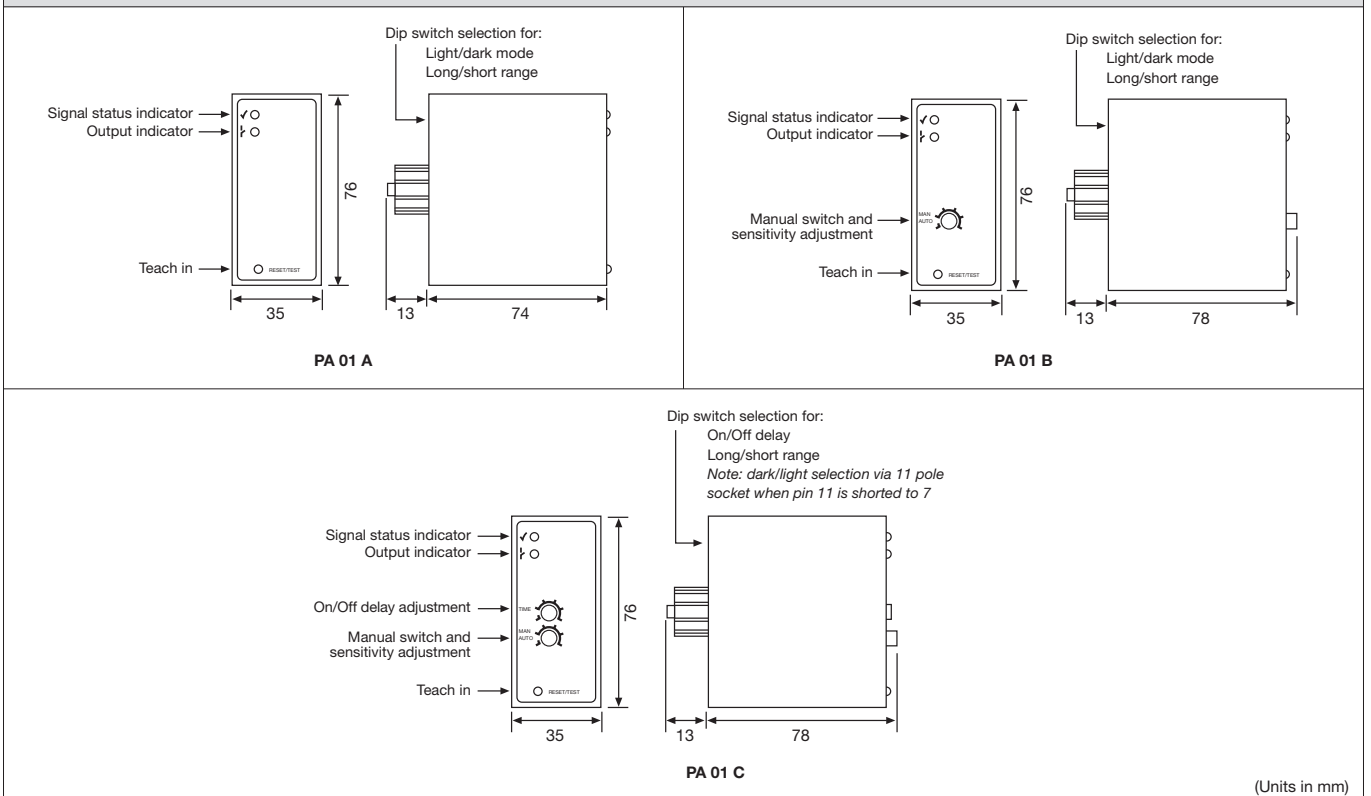

(Units in mm)

Telco reserves the right to change specifications without notice.

Description

- Operation mode and max sensing range:
Thru-beam: 0-60 m
Diffuse proximity: 0-4 m
- 230 V ac, 115 V ac, 24 V ac or 24 V dc supply voltage
- Manual sensitivity adjustment
- 1 relay or 1 transistor output
- Switch selectable light or dark function
- Switch selectable long or short range
- Power and output indicators
- 11-pole DIN socket connection



The PA 10 is a 1-channel photoelectric amplifier. The PA 10 A is to be used in conjunction with a remote transmitter LT and receiver LR from series 101, whilst the PA 10 B is intended for use with series 100, 110, and 120.

This amplifier series offers manual sensitivity adjustment via an integral potentiometer located on the front panel of the amplifier. Output can be selected from either a relay or an NPN/PNP transistor output. Light or dark function and long or short range are switch selectable.

Technical Data		
Supply voltage		24 V dc, 24 V ac, 115 V ac or 230 V ac
Voltage tolerance		+/- 15 %
Current consumption		Max. 3,2 VA
Output	Relay	1 open / 1 close, 250 V ac / 3 A, 120 V ac / 5 A
	Transistor	40 mA / 30 V dc
Alarm output		-
Power on indicator		Green LED
Output indicator		Red LED
Signal level indicator		-
LR sensor failure indicator		-
LT sensor failure indicator		-
Sensor monitor LED drive		-
Hysteresis		Approx. 40 %
Operation frequency	Relay	10 Hz
	Transistor	12 Hz
Response time t_{ON} / t_{OFF}	Relay	50 ms / 50 ms
	Transistor	40 ms / 40 ms
Delay t_{ON} / t_{OFF}		-
Housing material		Noryl

Environmental Data		
Temperature, operation		-10 to +50 °C
Temperature, storage		-40 to +80 °C
Sealing class		IP 40
Approvals		CE, UL, RoHS

Available Types

Model	Connection	Time Delay	Supply Voltage	24 V dc	24 V ac	115 V ac	230 V ac
			Output	Order Reference			
PA 10 A	11-pole DIN socket	-	Relay	PA 10 A 513	PA 10 A 512	PA 10 A 511	PA 10 A 510
			NPN and PNP	PA 10 A 613	PA 10 A 612	PA 10 A 611	PA 10 A 610
-		Relay	PA 10 B 513	PA 10 B 512	PA 10 B 511	PA 10 B 510	
		NPN and PNP	PA 10 B 613	PA 10 B 612	PA 10 B 611	PA 10 B 610	

Note: Remote sensors and 11-pole DIN socket to be ordered separately.

Applicable Remote Sensors and Ranges

Series	Thru-beam	Diffuse Proximity
101 (only PA 10 A)	11 m	0,9 m
100 (only PA 10 B)	15 m	1,1 m
110 (only PA 10 B)	35 m	2,0 m
120 (only PA 10 B)	60 m	4,0 m

Wiring Diagrams

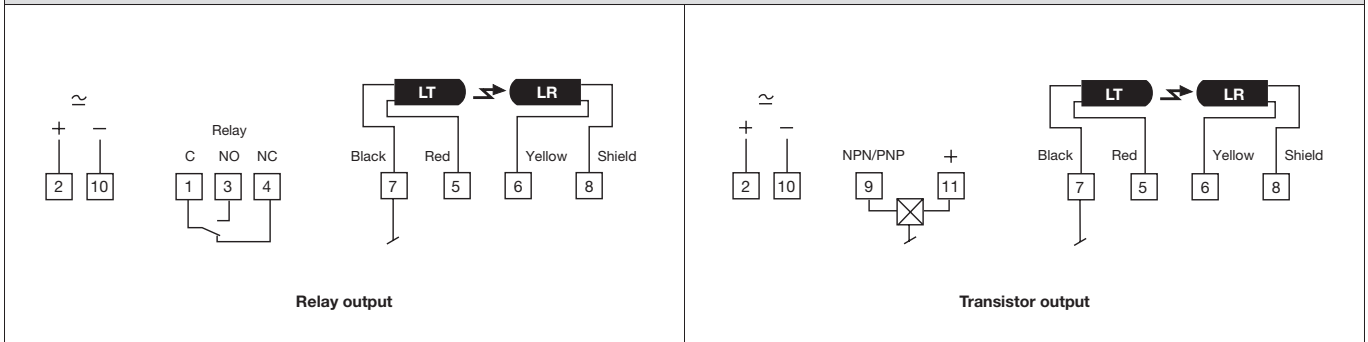

Dimensions and Descriptions

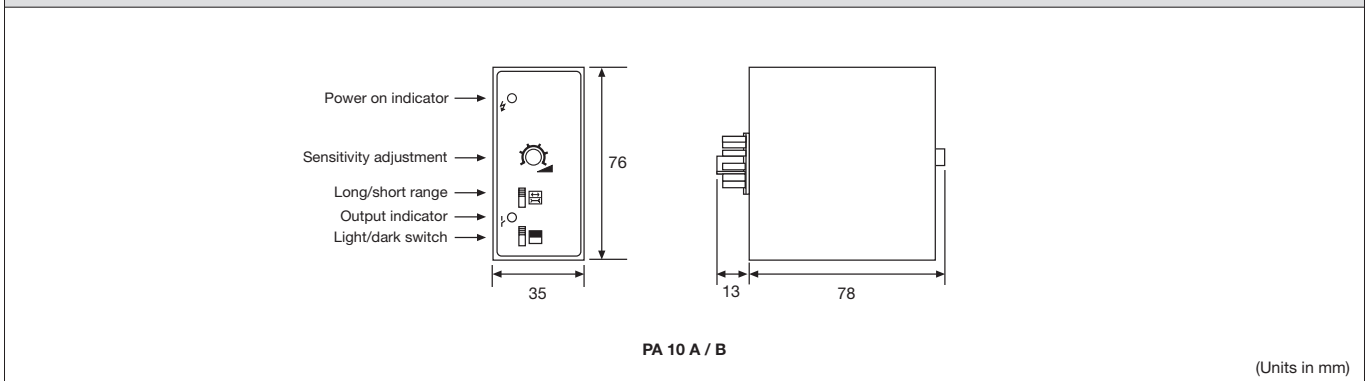

Telco reserves the right to change specifications without notice.

Description

- Operation mode and max sensing range:
Thru-beam: 0-70 m
Diffuse proximity: 0-5 m
- 230 V ac, 115 V ac, 24 V ac or 24 V dc supply voltage
- Manual sensitivity adjustment
- Sensor LED-drive
- Automatic sensor test
- Adjustable on/off time delay
- 1 relay and transistor output or 2 transistor outputs
- Switch selectable light or dark function
- Switch selectable long or short range
- Power, output, sensor test and signal level indicators
- 11-pole DIN socket connection



The PA 11 is a 1-channel photoelectric amplifier, which is to be used in conjunction with a set of remote transmitter LT and receiver LR from the series 100, 110 and 120.

This amplifier series offers manual sensitivity adjustment via integral potentiometers located on the front panel of the amplifier. Output can be selected from either a relay and NPN or NPN and PNP transistor outputs with or without a 0-10 sec on/off time delay. Light or dark function and long or short range are switch selectable.

The microprocessor controlled sensor test ensures that the system will automatically detect and indicate a faulty transmitter or receiver – cable break or electrical failure – during operation, through the relevant LED located on the front panel. The sensor LED drive powers the optional monitor LEDs available on the remote sensors – output (LT) and power (LR).

Technical Data		
Supply voltage		24 V dc, 24 V ac, 115 V ac or 230 V ac
Voltage tolerance		+/- 15 %
Current consumption		Max. 3,5 VA
Output	Relay	1 open / 1 close, 250 V ac / 3 A, 120 V ac / 5 A
	Transistor	
Alarm output		-
Power on indicator		Green LED
Output indicator		Yellow LED
Signal level indicator		Green LED
LR sensor failure indicator		Red LED
LT sensor failure indicator		Red LED
Sensor monitor LED drive		The green monitor LED on the receiver indicates 'Power ON' The yellow monitor LED on the transmitter indicates 'PA 11 output activated'
Hysteresis		Approx. 45 %
Operation frequency	Relay	14 Hz
	Transistor	20 Hz
Response time t_{ON} / t_{OFF}	Relay	35 ms / 35 ms
	Transistor	25 ms / 25 ms
Delay t_{ON} / t_{OFF}	PA 11 A	0-10 sec, adjustable
Housing material		Noryl

Environmental Data		
Temperature, operation		-10 to +50 °C
Temperature, storage		-40 to +80 °C
Sealing class		IP 40
Approvals		CE eNULUS

Available Types

Model	Connection	Time Delay	Supply Voltage	24 V dc	24 V ac	115 V ac	230 V ac
			Output	Order Reference			
PA 11 A	11-pole DIN socket	On/Off delay	Relay and NPN	PA 11 A 303T	PA 11 A 302T	PA 11 A 301T	PA 11 A 300T
			NPN and PNP	PA 11 A 403T	PA 11 A 402T	PA 11 A 401T	PA 11 A 400T
-		Relay and NPN	PA 11 B 303T	PA 11 B 302T	PA 11 B 301T	PA 11 B 300T	
		NPN and PNP	PA 11 B 403T	PA 11 B 402T	PA 11 B 401T	PA 11 B 400T	

Note: Remote sensors and 11-pole DIN socket to be ordered separately.

Applicable Remote Sensors and Ranges

Series	Thru-beam	Diffuse Proximity
100	18 m	1,3 m
110	40 m	2,7 m
120	70 m	5,0 m

Wiring Diagrams

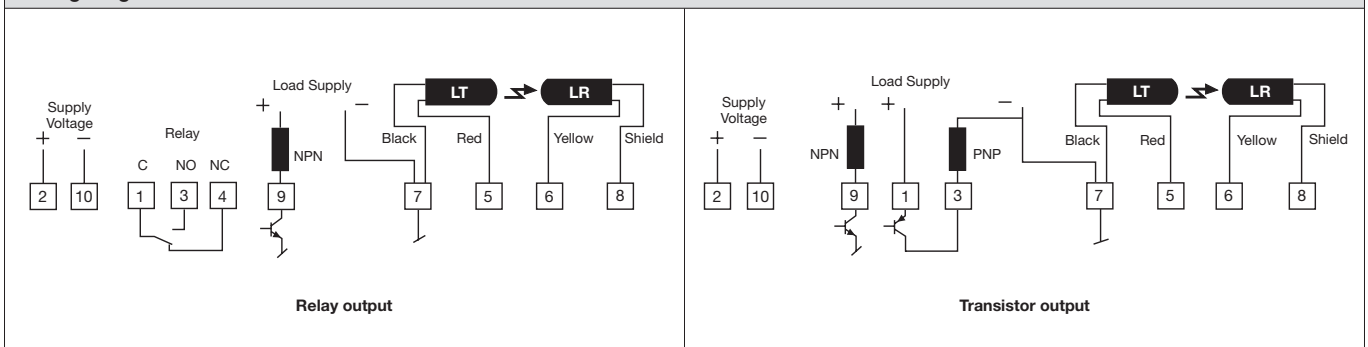

Dimensions and Descriptions

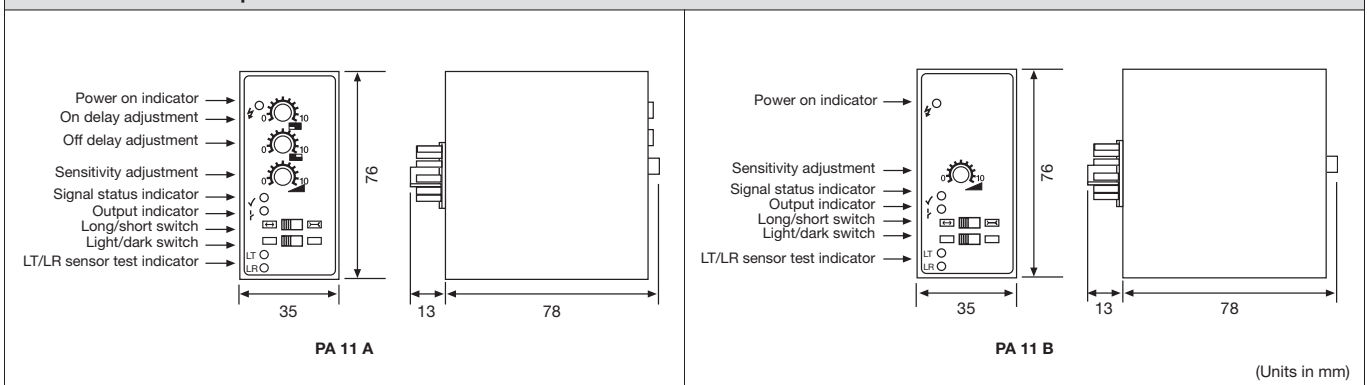

Telco reserves the right to change specifications without notice.

Description

- Operation mode and max sensing range:
Thru-beam: 0-70 m
Diffuse proximity: 0-5 m
- 24 V ac/dc supply voltage
- Manual sensitivity adjustment
- Sensor LED-drive
- Automatic sensor test
- Adjustable on/off time delay
- 1 relay or 1 transistor output
- Switch selectable light or dark function
- Switch selectable long or short range
- Test input
- Power, output, sensor test and signal level indicators
- Alarm output
- DIN rail mounting



The PA 15 is a 1-channel photoelectric amplifier, which is to be used in conjunction with a set of remote transmitter LT and receiver LR from the series 100, 110 and 120.

This amplifier series offers manual sensitivity adjustment via an integral potentiometer located on the front panel of the amplifier. Output can be selected from either a relay or transistor output, with or without an adjustable 0-10 sec on/off time delay. Light or dark function and long or short range are switch selectable.

The microprocessor controlled sensor test ensures that the system will automatically detect and indicate a faulty transmitter or receiver – cable break or electrical failure – during operation, through the relevant LED located on the front panel.

The amplifier offers a test input, which is used for either disabling or enabling the transmitting power temporarily for test purposes. The amplifier includes an alarm output which is used to indicate if the signal level is insufficient or if a sensor is faulty. The sensor LED drive powers the optional monitor LEDs available on the remote sensors – output (LT) and power (LR).

Technical Data		
Supply voltage		15-30 V dc or 24 V ac
Voltage tolerance		+/- 10 %
Current consumption		Max. 2,5 W
Output	Relay	250 V ac / 3 A, 120 V ac / 5A
	Transistor	30 V dc / 60 mA
Alarm output	Transistor	12-30 V dc / 10 mA
Power on indicator		Green LED
Output indicator		Yellow LED
Signal level indicator		Green LED
LR sensor failure indicator		Red LED
LT sensor failure indicator		Red LED
Sensor monitor LED drive		Green monitor LED on receiver indicates 'Power ON' Yellow monitor LED on the transmitter indicates 'PA output activated'
Hysteresis		Approx. 45 %
Operation frequency	Relay	14 Hz
	Transistor	20 Hz
Response time t_{ON} / t_{OFF}	Relay	35 ms / 35 ms
	Transistor	25 ms / 25 ms
Delay t_{ON} / t_{OFF}	PA 15 A	0-10 sec, adjustable
Housing material		Polyamide

Environmental Data

Temperature, operation	-10 to +50 °C
Temperature, storage	-40 to +80 °C
Sealing class	IP 40
Approvals	CE

Available Types

Model	Connection	Time Delay	Supply Voltage	24 V ac / dc	
			Output	Order Reference	
PA 15 A	Removable screw terminals	On/Off delay	Relay	PA 15 A 009	
			NPN	PA 15 A 109	
			PNP	PA 15 A 209	
PA 15 B		-	-	Relay	PA 15 B 009
				NPN	PA 15 B 109
				PNP	PA 15 B 209

Note: Remote sensors to be ordered separately.

Applicable Remote Sensors and Ranges

Series	Thru Beam	Diffuse Proximity
100	18 m	1,3 m
110	40 m	2,7 m
120	70 m	5,0 m

Wiring Diagrams

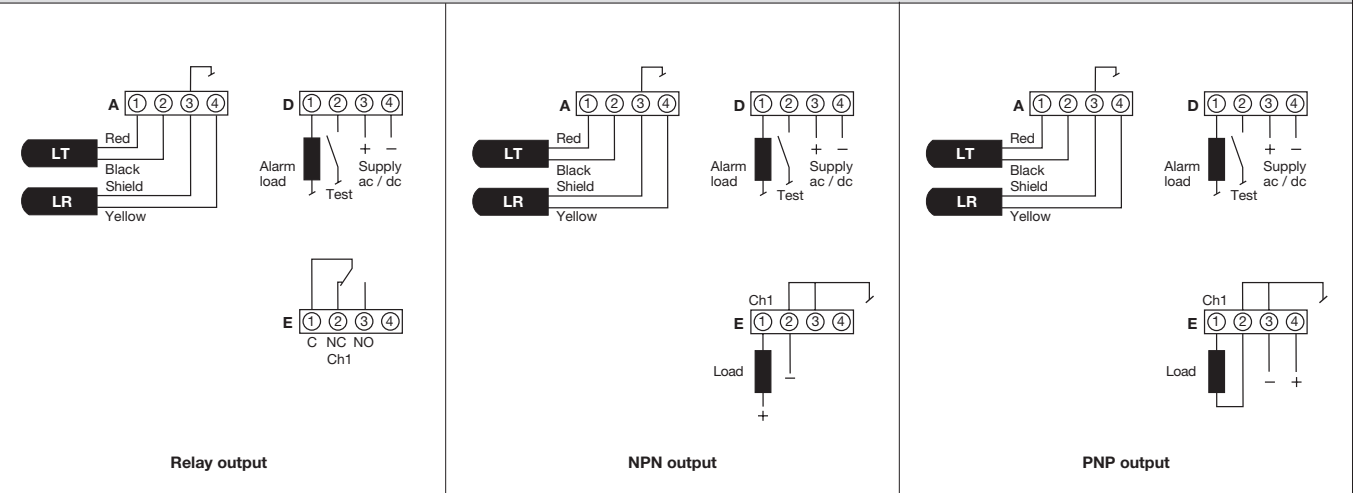

Dimensions and Descriptions

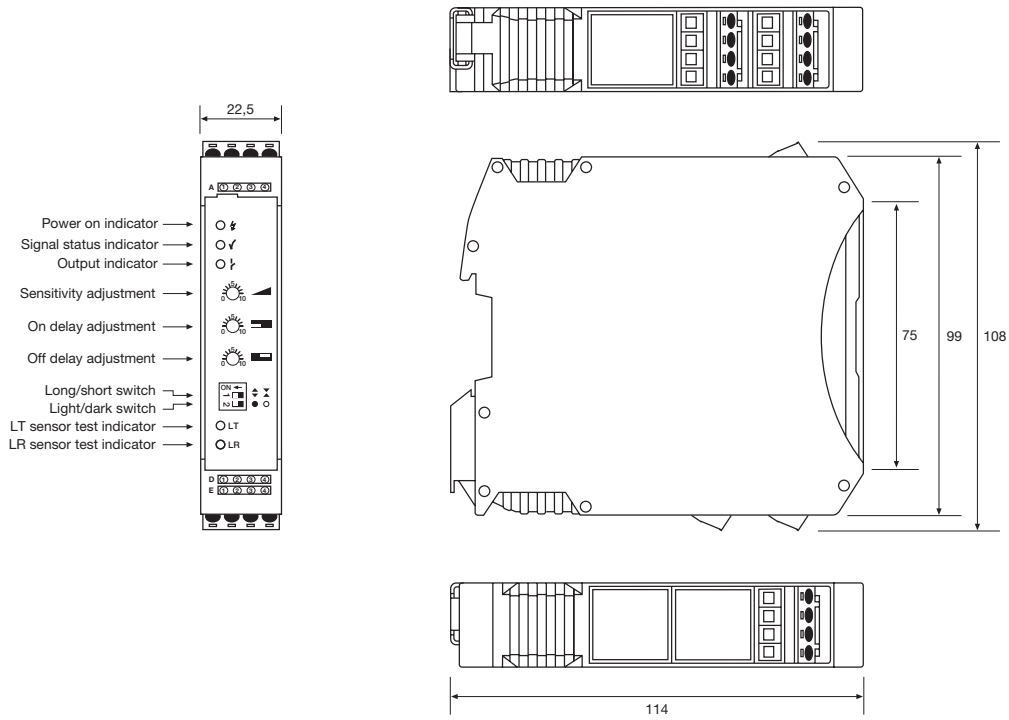

PA 15 A

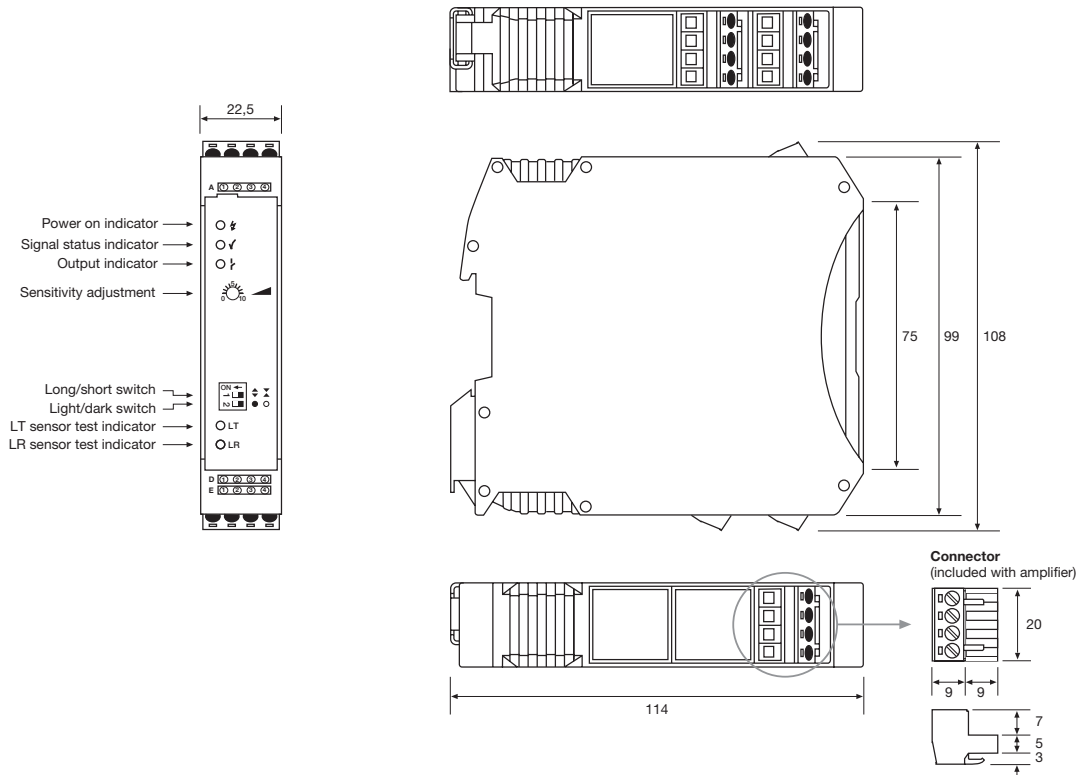

PA 15 B

(Units in mm)

Telco reserves the right to change specifications without notice.

MULTIPLEXED AMPLIFIER SERIES

In an industry where most products resemble each other, we have strived to make sure that Telco only resembles Telco – in terms of quality, reliability, performance and ease-of-use. This is no different for the multiplexed amplifier series, which has withstood the test of time for that exact reason.

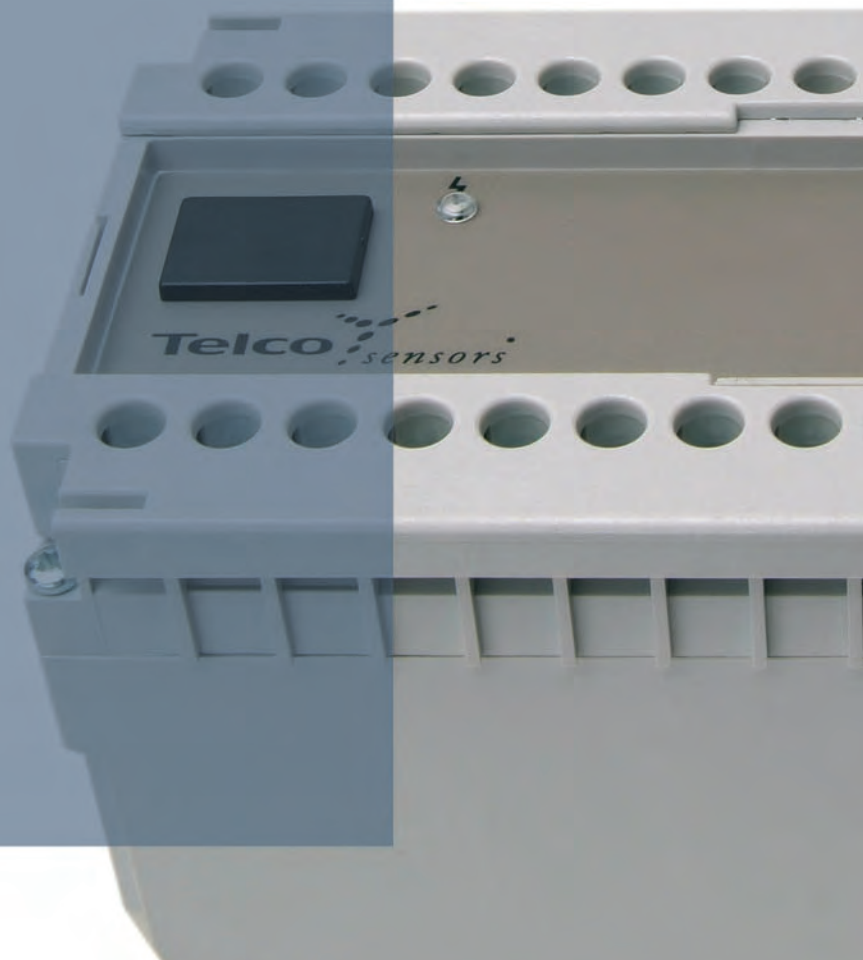

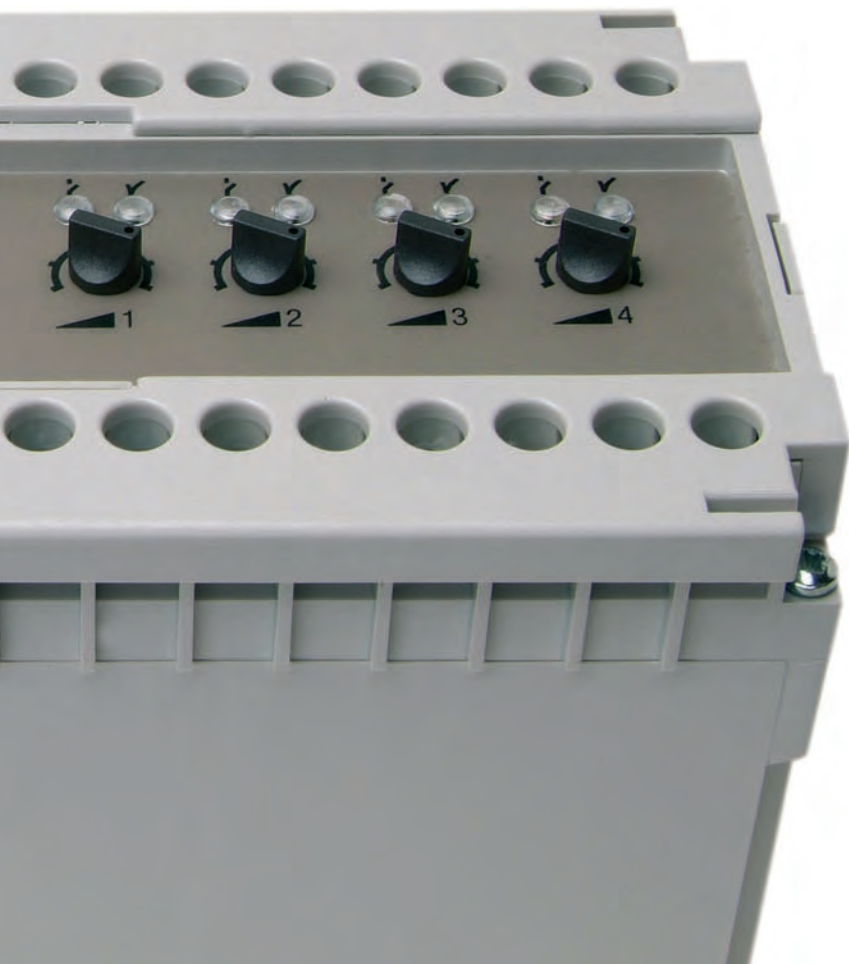

Description

- Operation mode and max sensing range:
Thru-beam: 0-45 m
Diffuse proximity: 0-3,5 m
- 230 V ac, 115 V ac, 24 V ac or 24 V dc supply voltage
- Manual sensitivity adjustment
- Adjustable on/off time delay
- 2 relays or 2 transistor outputs
- Power, output and signal level indicators
- Switch selectable light or dark function
- Switch selectable long or short range
- 11-pole DIN socket connection



The MPA 21 is a 2-channel, multiplexed photoelectric amplifier, which is to be used in conjunction with 2 sets of remote transmitters LT and receivers LR, from the series 100, 110 and 120.

The 2 channels operate independently of each other with their own set of remote transmitter and receiver. The multiplexing function ensures that optical cross talk between channels is prevented.

The series offers a choice between 2 individual relays or 2 individual NPN/PNP transistor outputs, with or without an adjustable 0-3 sec on/off time delay.

This amplifier series offers manual sensitivity adjustment for each individual channel via integral potentiometers located on the front panel of the amplifier. Light or dark function and long or short range are switch selectable for each individual channel.

Technical Data		
Supply voltage		24 V dc, 24 V ac, 115 V ac or 230 V ac
Voltage tolerance		+/- 15 %
Current consumption		Max. 3 VA
Output	Relay	1 open / 1 close, 250 V ac / 3 A, 120 V ac / 5 A
	Transistor	40 mA / 30 V dc
Alarm output		-
Power on indicator		Green LED
Output indicator		Red LED
Signal level indicator		Green LED
LR sensor failure indicator		-
LT sensor failure indicator		-
Sensor monitor LED drive		-
Hysteresis		Approx. 35 %
Operation frequency	Relay	9 Hz
	Transistor	11 Hz
Response time t _{ON} / t _{OFF}	Relay	55 ms / 55 ms
	Transistor	45 ms / 45 ms
Delay t _{ON} / t _{OFF}	MPA 21 A	0-3 sec, adjustable
Housing material		Noryl

Environmental Data		
Temperature, operation		-10 to +50 °C
Temperature, storage		-40 to +80 °C
Sealing class		IP 40
Approvals		CE PA CB

Available Types

Model	Connection	Time Delay	Supply Voltage	24 V dc	24 V ac	115 V ac	230 V ac
			Output	Order Reference			
MPA 21 A	11-pole DIN socket	On/Off delay	2 individual relays	MPA 21 A 503	MPA 21 A 502	MPA 21 A 501	MPA 21 A 500
			2 individual NPN/PNP	MPA 21 A 603	MPA 21 A 602	MPA 21 A 601	MPA 21 A 600
-		2 individual relays	MPA 21 B 503	MPA 21 B 502	MPA 21 B 501	MPA 21 B 500	
		2 individual NPN/PNP	MPA 21 B 603	MPA 21 B 602	MPA 21 B 601	MPA 21 B 600	

Note: Remote sensors and 11-pole DIN socket to be ordered separately.

Applicable Remote Sensors and Ranges

Series	Thru-beam	Diffuse Proximity
100	10 m	0,7 m
110	25 m	1,6 m
120	45 m	3,5 m

Wiring Diagrams

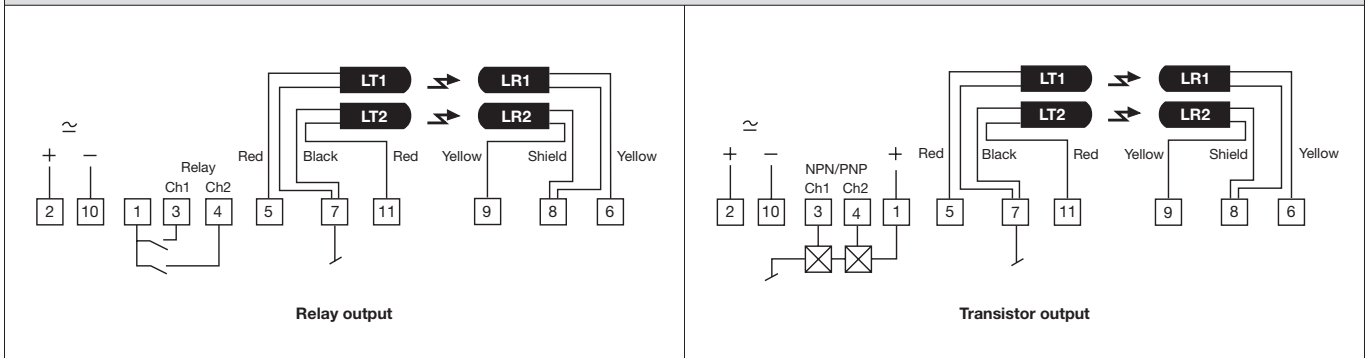

Dimensions and Descriptions

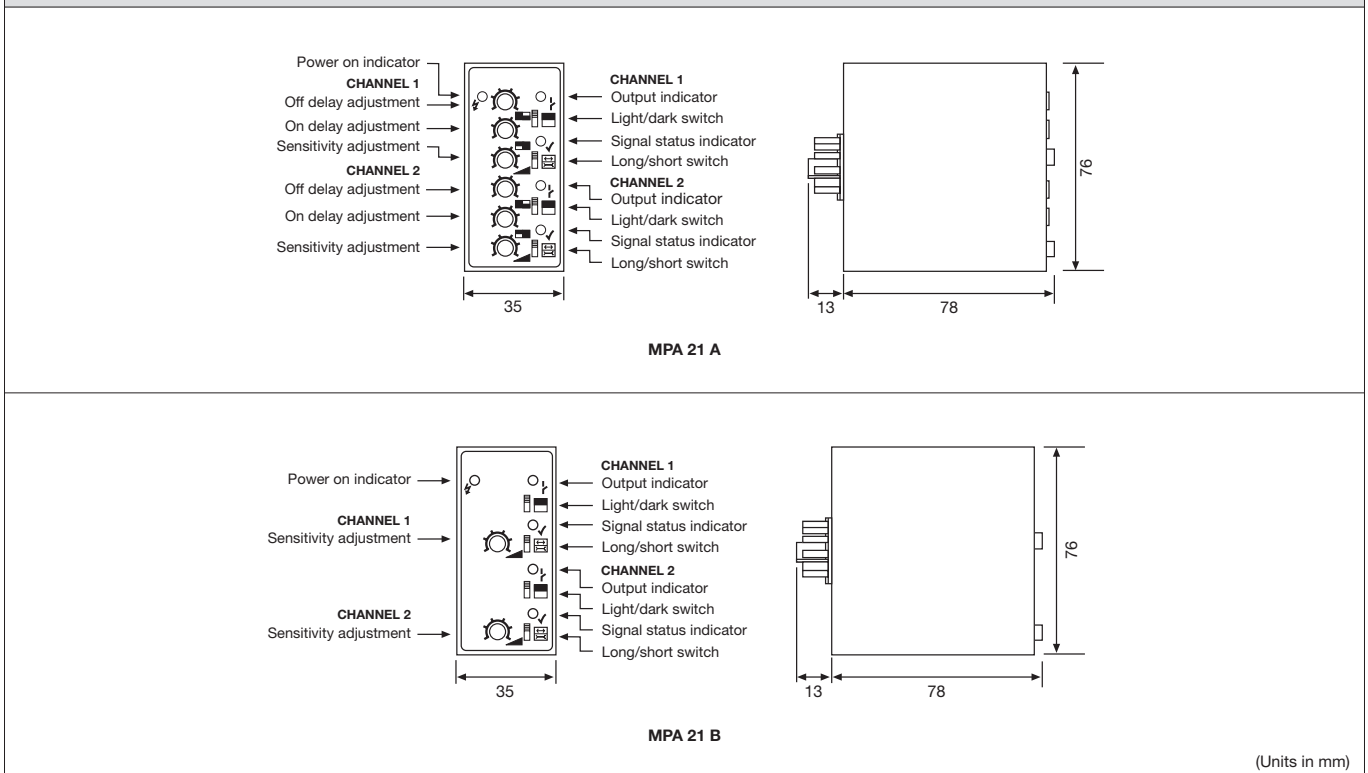

Telco reserves the right to change specifications without notice.

Description

- Operation mode and max sensing range:
Thru-beam: 0-35 m
Diffuse proximity: 0-2 m
- 230 V ac, 115 V ac, 24 V ac or 24 V dc supply voltage
- Manual sensitivity adjustment
- Adjustable on/off time delay
- 4 relays and/or 4 transistor individual outputs
- 1 relay and 1 transistor common output
- Switch selectable light or dark function
- Switch selectable long or short range
- Power, output and signal level indicators
- Screw terminals connection



The MPA 41 is a 4-channel, multiplexed photoelectric amplifier, which is to be used in conjunction with 4 sets of remote transmitters LT and receivers LR, from the series 100, 110 and 120.

The 4 channels operate independently of each other with their own set of remote transmitter and receiver. The multiplexing function ensures that optical cross talk between channels is prevented. The series offers a choice between 4 individual relays and/or 4 individual NPN/PNP

transistor outputs, or 1 common relay and 1 common transistor output which features an adjustable 0-10 sec on/off time delay.

This amplifier series offers manual sensitivity adjustment for each individual channel via integral potentiometers located on the front panel of the amplifier. Light or dark function and long or short range are switch selectable for each individual channel.

Technical Data			MPA 41 A	MPA 41 B	MPA 41 C	MPA 41 D
Supply voltage			24 V dc, 24 V ac, 115 V ac or 230 V ac			
Voltage tolerance			+/- 15 %			
Current consumption			Max. 6,5 VA			
Output	Relay		1 open / 1 close, 250 V ac / 3 A, 120 V ac / 5 A			
	Transistor		40 mA / 30 V dc			
Alarm output			-			
Power on indicator			Green LED			
Output indicator			Red LED			
Signal level indicator			Green LED			
LR sensor failure indicator			-			
LT sensor failure indicator			-			
Sensor monitor LED drive			-			
Hysteresis			Approx. 35 %			
Operation frequency	Relay	Short range	14 Hz		25 Hz	
		Long range	8 Hz		17 Hz	
	Transistor	Short range	20 Hz		50 Hz	
		Long range	10 Hz		25 Hz	
Response time t_{ON} / t_{OFF}	Relay	Short range	35 ms / 35 ms		20 ms / 20 ms	
		Long range	60 ms / 60 ms		30 ms / 30 ms	
	Transistor	Short range	25 ms / 25 ms		10 ms / 10 ms	
		Long range	50 ms / 50 ms		20 ms / 20 ms	
Delay t_{ON} / t_{OFF}			-	0-10 sec, adjustable		-
Housing material			Polycarbonate			

Environmental Data	
Temperature, operation	-10 to +50 °C
Temperature, storage	-40 to +80 °C
Sealing class	IP 30
Approvals	CE, UL, CE

Available Types

Model	Connection	Time Delay	Supply Voltage	24 V dc	24 V ac	115 V ac	230 V ac
			Output	Order Reference			
MPA 41 A	Screw terminals	-	4 individual NPN/PNP	MPA 41 A 603	MPA 41 A 602	MPA 41 A 601	MPA 41 A 600
			4 individual relays and 4 individual NPN/PNP	MPA 41 A 703	MPA 41 A 702	MPA 41 A 701	MPA 41 A 700
On/Off delay		1 common relay and 1 common NPN/PNP	MPA 41 B 703	MPA 41 B 702	MPA 41 B 701	MPA 41 B 700	
MPA 41 C		-	4 individual NPN/PNP	MPA 41 C 603	MPA 41 C 602	MPA 41 C 601	MPA 41 C 600
			4 individual relays and 4 individual NPN/PNP	MPA 41 C 703	MPA 41 C 702	MPA 41 C 701	MPA 41 C 700
MPA 41 D		On/Off delay	1 common relay and 1 common NPN/PNP	MPA 41 D 703	MPA 41 D 702	MPA 41 D 701	MPA 41 D 700

Note: Remote sensors to be ordered separately.

Applicable Remote Sensors and Ranges

Series	Thru-beam		Diffuse Proximity	
	Short range	Long range	Short range	Long range
MPA 41 A/B				
100	4 m	8 m	0,4 m	0,6 m
110	9 m	18 m	0,7 m	1,3 m
120	18 m	35 m	1,3 m	2,0 m
MPA 41 C/D				
100	2 m	4 m	0,2 m	0,4 m
110	5 m	9 m	0,4 m	0,7 m
120	9 m	18 m	0,7 m	1,3 m

Wiring Diagrams

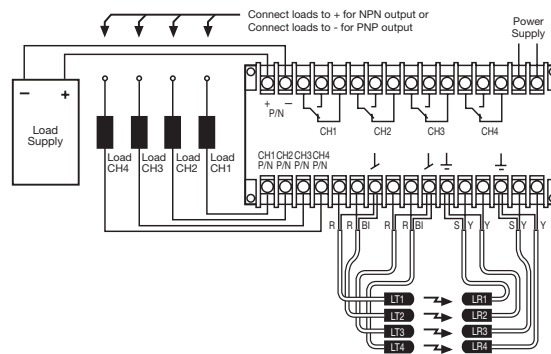

MPA 41 A/C

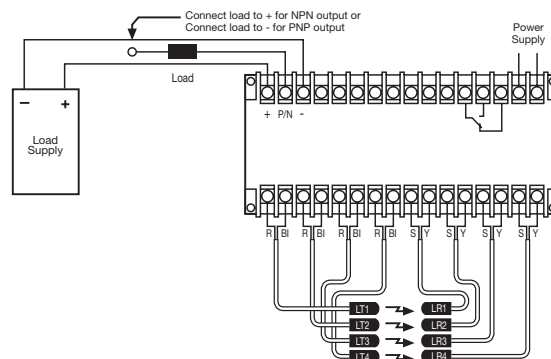

MPA 41 B/D

Dimensions and Descriptions

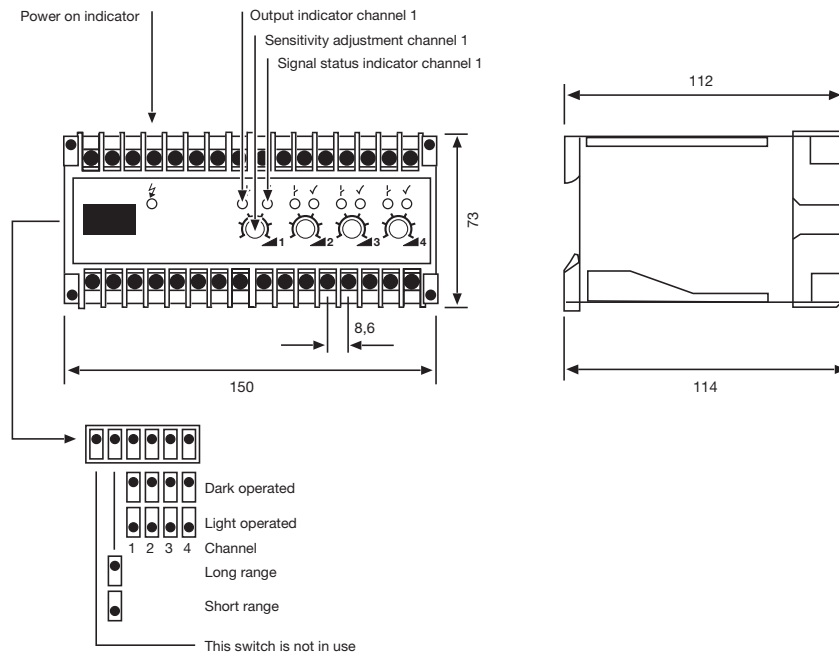

MPA 41 A/C

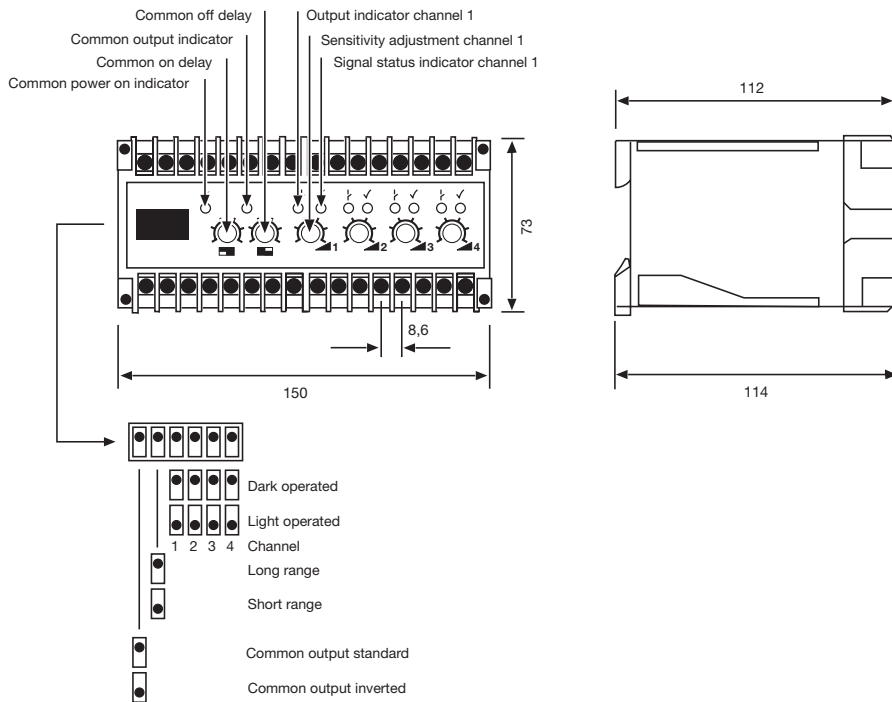

MPA 41 B/D

(Units in mm)

Telco reserves the right to change specifications without notice.

Description

- Operation mode and max sensing range:
Thru-beam: 0-35 m
Diffuse proximity: 0-2 m
- 230 V ac, 115 V ac, 24 V ac or 24 V dc supply voltage
- Manual sensitivity adjustment
- Adjustable on/off time delay
- 8 relays or 8 transistor individual outputs
- 1 relay and 1 transistor common output
- Switch selectable light or dark function
- Switch selectable long or short range
- Power, output and signal level indicators
- Screw terminals connection



The MPA 81 is an 8-channel, multiplexed photoelectric amplifier, which is to be used in conjunction with 8 sets of remote transmitters LT and receivers LR, from the series 100, 110 and 120.

The 8 channels operate independently of each other with their own set of remote transmitter and receiver. The multiplexing function ensures that optical cross talk between channels is prevented. The series offers a choice between 8 individual relays or 8 individual NPN/PNP transistor

outputs, or 1 common relay and 1 common NPN/PNP transistor output which has an adjustable 0-10 sec on-off time delay.

This amplifier series offers manual sensitivity adjustment for each individual channel, via integral potentiometers located on the front panel of the amplifier. Light or dark function and long or short range are switch selectable for each individual channel.

Technical Data			MPA 81 A	MPA 81 B	MPA 81 C	MPA 81 D
Supply voltage			24 V dc, 24 V ac, 115 V ac or 230 V ac			
Voltage tolerance			+/- 15 %			
Current consumption			Max. 6,5 VA			
Output	Relay		1 open / 1 close, 250 V ac / 3 A, 120 V ac / 5 A			
	Transistor		40 mA / 30 V dc			
Alarm output			-			
Power on indicator			Green LED			
Output indicator			Red LED			
Signal level indicator			Green LED			
LR sensor failure indicator			-			
LT sensor failure indicator			-			
Sensor monitor LED drive			-			
Hysteresis			Approx. 35 %			
Operation frequency	Relay	Short range	9 Hz		18 Hz	
		Long range	5 Hz		11 Hz	
	Transistor	Short range	11 Hz		28 Hz	
		Long range	6 Hz		14 Hz	
Response time t_{ON} / t_{OFF}	Relay	Short range	55 ms / 55 ms		28 ms / 28 ms	
		Long range	100 ms / 100 ms		46 ms / 46 ms	
	Transistor	Short range	45 ms / 45 ms		18 ms / 18 ms	
		Long range	90 ms / 90 ms		36 ms / 36 ms	
Delay t_{ON} / t_{OFF}			-	0-10 sec, adjustable		-
Housing material			Polycarbonate			

Environmental Data

Temperature, operation	-10 to +50 °C
Temperature, storage	-40 to +80 °C
Sealing class	IP 30
Approvals	CE RA CB

Available Types

Model	Connection	Time Delay	Supply Voltage	24 V dc	24 V ac	115 V ac	230 V ac
			Output	Order Reference			
MPA 81 A	Screw terminals	-	8 individual relays	MPA 81 A 503	MPA 81 A 502	MPA 81 A 501	MPA 81 A 500
			8 individual NPN/PNP	MPA 81 A 603	MPA 81 A 602	MPA 81 A 601	MPA 81 A 600
On/Off delay		1 common relay and 1 common NPN/PNP	MPA 81 B 703	MPA 81 B 702	MPA 81 B 701	MPA 81 B 700	
MPA 81 C		-	8 individual relays	MPA 81 C 503	MPA 81 C 502	MPA 81 C 501	MPA 81 C 500
			8 individual NPN/PNP	MPA 81 C 603	MPA 81 C 602	MPA 81 C 601	MPA 81 C 600
MPA 81 D		On/Off delay	1 common relay and 1 common NPN/PNP	MPA 81 D 703	MPA 81 D 702	MPA 81 D 701	MPA 81 D 700

Note: Remote sensors to be ordered separately.

Applicable Remote Sensors and Ranges

Series	Thru-beam		Diffuse Proximity	
	Short range	Long range	Short range	Long range
MPA 81 A/B				
100	4 m	8 m	0,4 m	0,6 m
110	9 m	18 m	0,7 m	1,3 m
120	18 m	35 m	1,3 m	2,0 m
MPA 81 C/D				
100	2 m	4 m	0,2 m	0,4 m
110	5 m	9 m	0,4 m	0,7 m
120	9 m	18 m	0,7 m	1,3 m

Wiring Diagrams

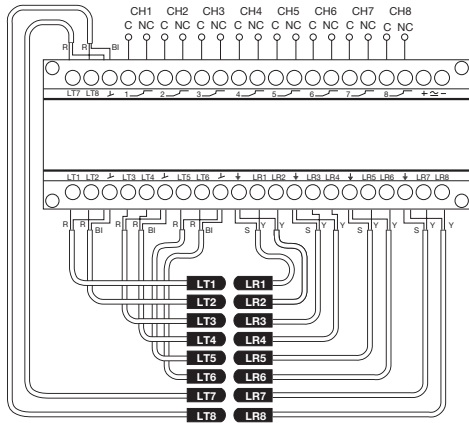

MPA 81 A/C 50x (Relay Output)

Wire Code	
R	Red
BI	Black
Y	Yellow
S	Shield

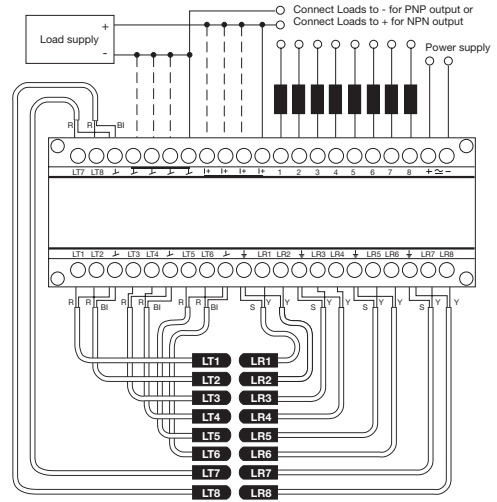

MPA 81 A/C 60x (Transistor Output)

Wire Code	
R	Red
BI	Black
Y	Yellow
S	Shield

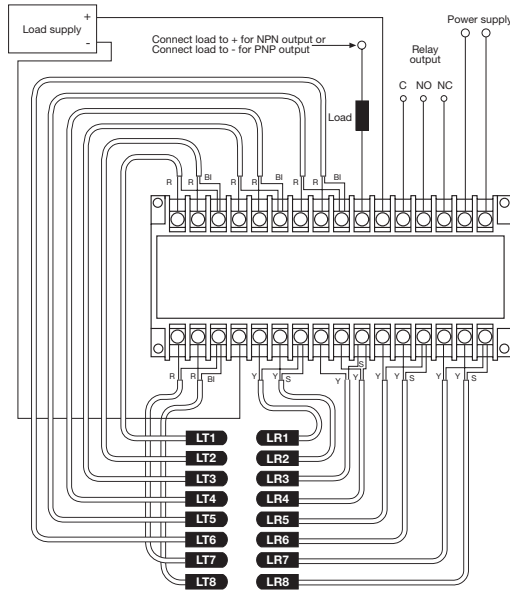

MPA 81 B/D (Relay/Transistor Output)

Wire Code	
R	Red
BI	Black
Y	Yellow
S	Shield

Dimensions and Descriptions

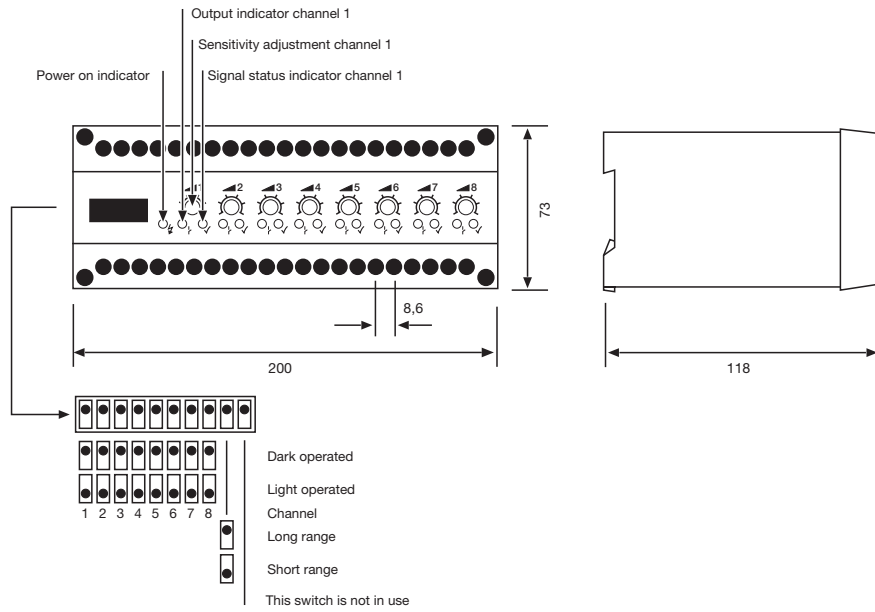

MPA 81 A/C

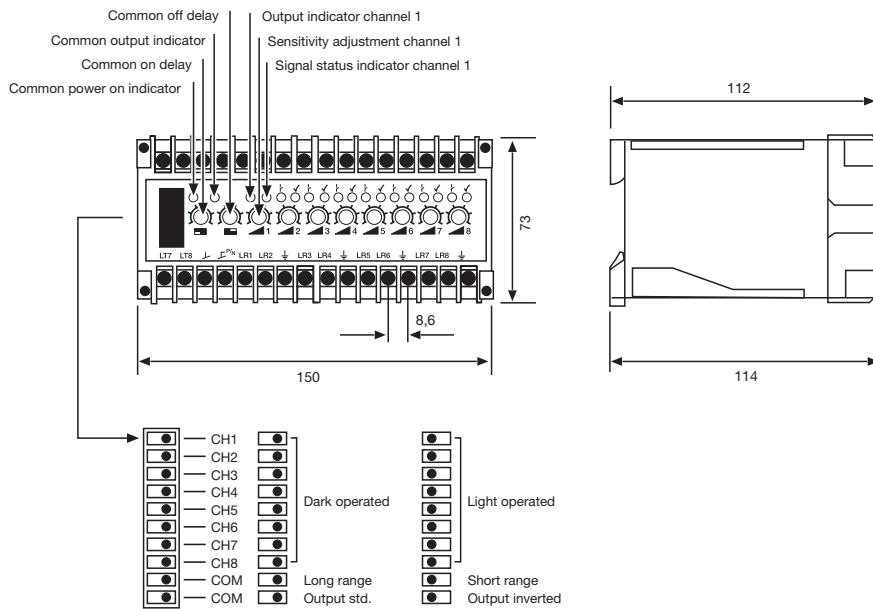

MPA 81 B/D

(Units in mm)

Telco reserves the right to change specifications without notice.



PHOTOELECTRIC AMPLIFIER BUS SERIES

This new generation of photoelectric amplifiers, pioneers master/slave multiplexing technology in an innovative and flexible modular design. It challenges all conventional thinking on how a photoelectric system should function – and with a versatile design and wide range of unique features it promises more flexibility than ever thought imaginable. Above all, it can proudly be labelled with the performance heritage that Telco has become renowned for over the past 25 years.

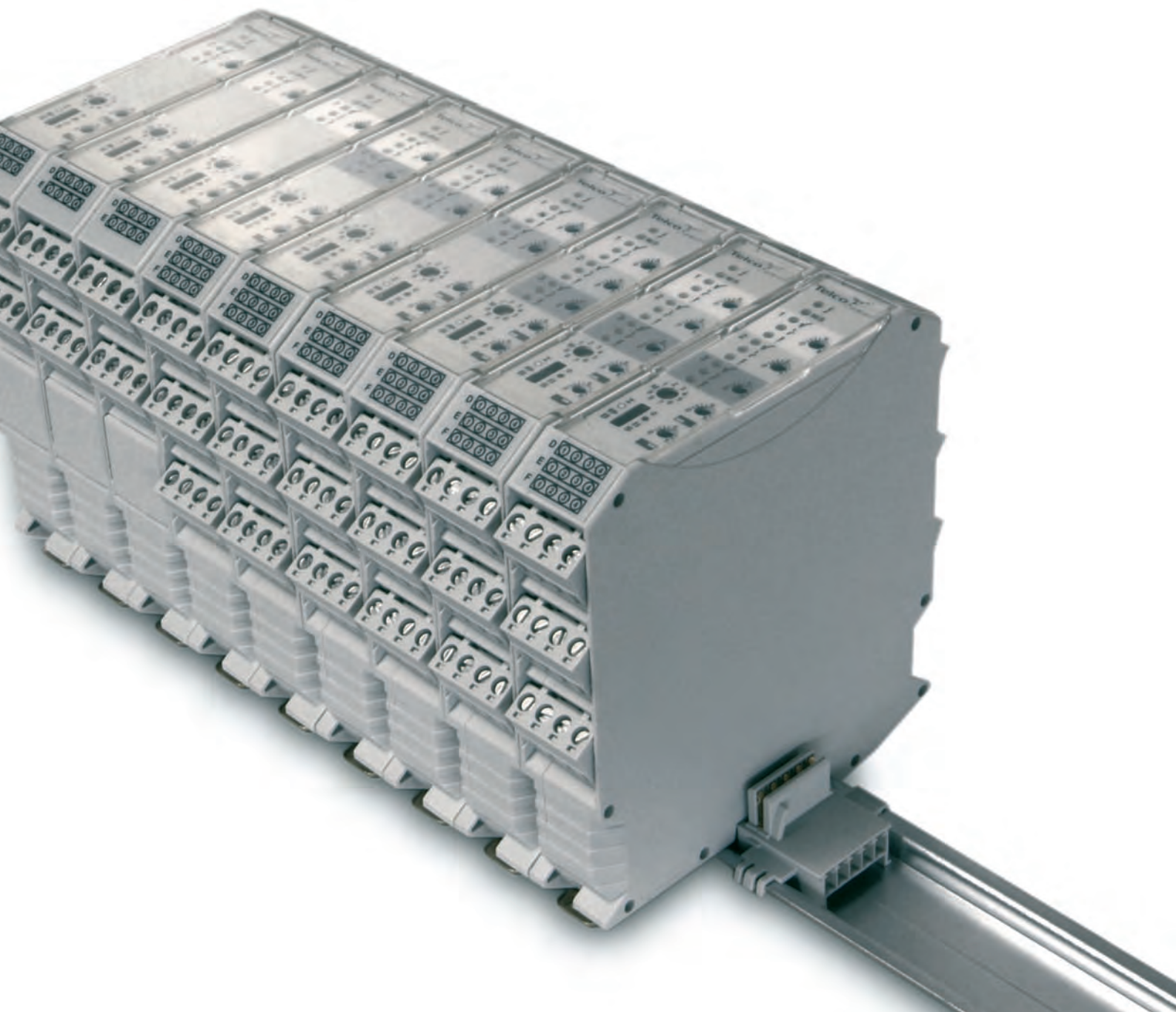

Description

- Operation mode and max sensing range:
Thru-beam: 0-70 m
Diffuse proximity: 0-4 m
- 10-30 V dc and 24 V ac supply voltage
- Manual sensitivity adjustment
- Sensor LED-drive
- Automatic sensor test
- Adjustable on/off time delay
- 1 relay or 1 transistor output
- Switch selectable light or dark function
- Switch selectable long or short range
- Test input
- Power, output, alarm, signal level and master/slave address indicators
- Alarm output
- DIN rail mounting with bus function



The PAB 10 is a 1-channel photoelectric amplifier, which is to be used in conjunction with a set of remote transmitter LT and receiver LR from the series 100, 110 and 120.

This amplifier series offers manual sensitivity adjustment via an integral potentiometer located on the front panel of the amplifier. Output can be selected from either a relay or transistor output, with an adjustable 0-10 sec on/off time delay. Light or dark function and long or short range are switch selectable.

The amplifiers from the PAB 10 A series can be connected together with up to 9 amplifiers from the PAB series via a bus rail connector positioned on the DIN rail, to form a modular master/slave system with up to a total of 28 channels. The bus connection enables communication between

the amplifiers, which allows the channels of all the amplifiers to be multiplexed ensuring that optical cross talk between channels is prevented and allows a common output from the amplifier modules. Both the PAB 10 A and PAB 10 S can share power supply via the bus connection.

The amplifier offers a test input, which is used for either disabling or enabling the transmitting power temporarily for test purposes. The amplifier includes an alarm output, which is used to indicate if the signal level is insufficient or if a sensor is faulty. The sensor LED drive powers the optional monitor LEDs available on the remote sensors – output (LT) and power (LR).

Technical Data			
Supply voltage		10-30 V dc or 24 V ac	
Voltage tolerance	ac	+/- 10 %	
Current consumption		Max. 1,7 W	
Output	Relay	250 V ac / 3 A, 120 V ac / 5A	
	Transistor	30 V dc / 100 mA	
Alarm output	Transistor	30 V dc / 100 mA	
Power on indicator		Green LED	
Output indicator		Yellow LED	
Signal level indicator		Green LED	
Alarm indicator		Red / yellow LED	
LR sensor failure indicator		Yellow LED	
LT sensor failure indicator		Red LED	
Master/slave address indicator	PAB 10 A	Green / orange LED	
Sensor monitor LED drive		Green monitor LED on receiver indicates 'Power ON' Yellow monitor LED on the transmitter indicates 'PAB output activated'	
Hysteresis		Approx. 35 %	
Operation frequency	Relay	Short range	21 Hz
		Long range	12 Hz
	Transistor	Short range	42 Hz
		Long range	17 Hz
Response time t_{ON} / t_{OFF}	Relay	Short range	27 ms / 20 ms
		Long range	45 ms / 38 ms
	Transistor	Short range	12 ms / 12 ms
		Long range	30 ms / 30 ms
Delay t_{ON} / t_{OFF}		0-10 sec, adjustable	
Housing material		Polyamide	

Environmental Data

Temperature, operation	-10 to +50 °C
Temperature, storage	-40 to +80 °C
Sealing class	IP 40
Approvals	CE 

Available Types

Model	Connection	Time Delay	Bus Function	Supply Voltage	10-30 V dc / 24 V ac
				Output	Order Reference
PAB 10 A	Removable screw terminals	On/Off delay 0-10 sec.	Master/Slave communication and Power supply	Relay	PAB 10 A 009
				NPN	PAB 10 A 109
				PNP	PAB 10 A 209
PAB 10 S			Power supply	Relay	PAB 10 S 009
				NPN	PAB 10 S 109
				PNP	PAB 10 S 209

Note: Remote sensors and bus rail connector to be ordered separately.

Applicable Remote Sensors and Ranges

Series	Amplifier Model	Mode	Thru-beam		Diffuse Proximity	
			Short range	Long range	Short range	Long range
100	PAB 10 A/S	Single	6 m	18 m	0,5 m	1,1 m
	PAB 10 A	Bus Modular	4 m	12 m	0,4 m	0,8 m
110	PAB 10 A/S	Single	13 m	40 m	0,9 m	2,7 m
	PAB 10 A	Bus Modular	9 m	27 m	0,7 m	1,7 m
120	PAB 10 A/S	Single	23 m	70 m	1,7 m	4,0 m
	PAB 10 A	Bus Modular	16 m	47 m	1,2 m	2,6 m

Response Times in Bus Connection

PAB 10 A

Response time	t_{ON}	Relay		Transistor	
		Short range	Long range	Short range	Long range
		$6 \text{ ms} \times (N + 1) + 15 \text{ ms}$	$15 \text{ ms} \times (N + 1) + 15 \text{ ms}$	$6 \text{ ms} \times (N + 1)$	$15 \text{ ms} \times (N + 1)$
Response time	t_{OFF}	$6 \text{ ms} \times (N + 1) + 8 \text{ ms}$	$15 \text{ ms} \times (N + 1) + 8 \text{ ms}$	$6 \text{ ms} \times (N + 1)$	$15 \text{ ms} \times (N + 1)$
	Operation frequency	$83 \text{ Hz} / (N + 2,9)$	$33 \text{ Hz} / (N + 1,8)$	$83 \text{ Hz} / (N + 1)$	$33 \text{ Hz} / (N + 1)$

Note: "N" is equal to the total number of channels connected in the bus connection.

Wiring Diagrams

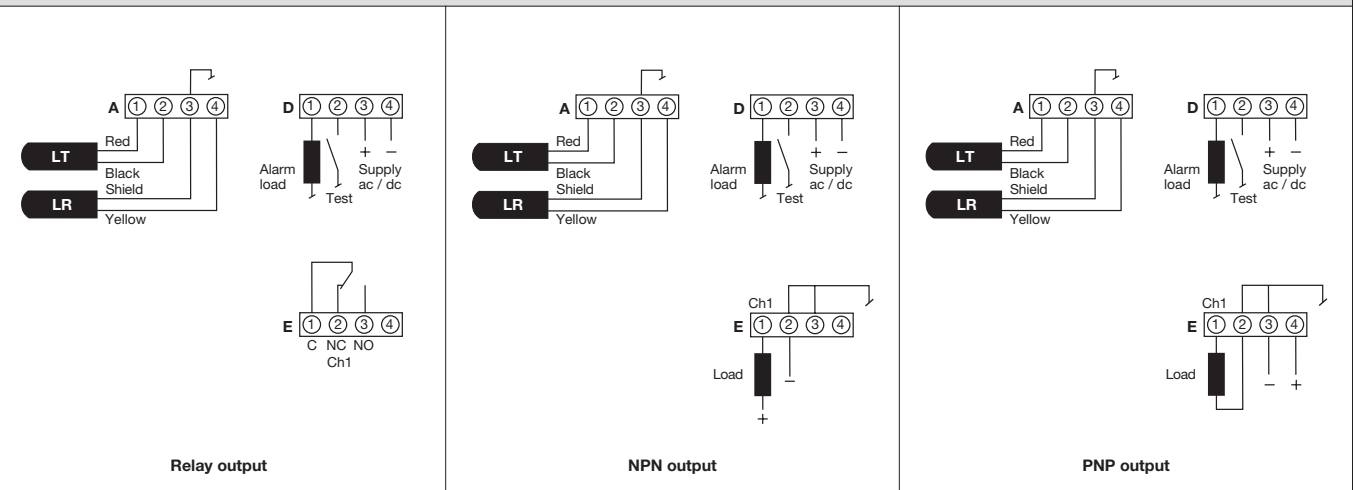

Dimensions and Descriptions

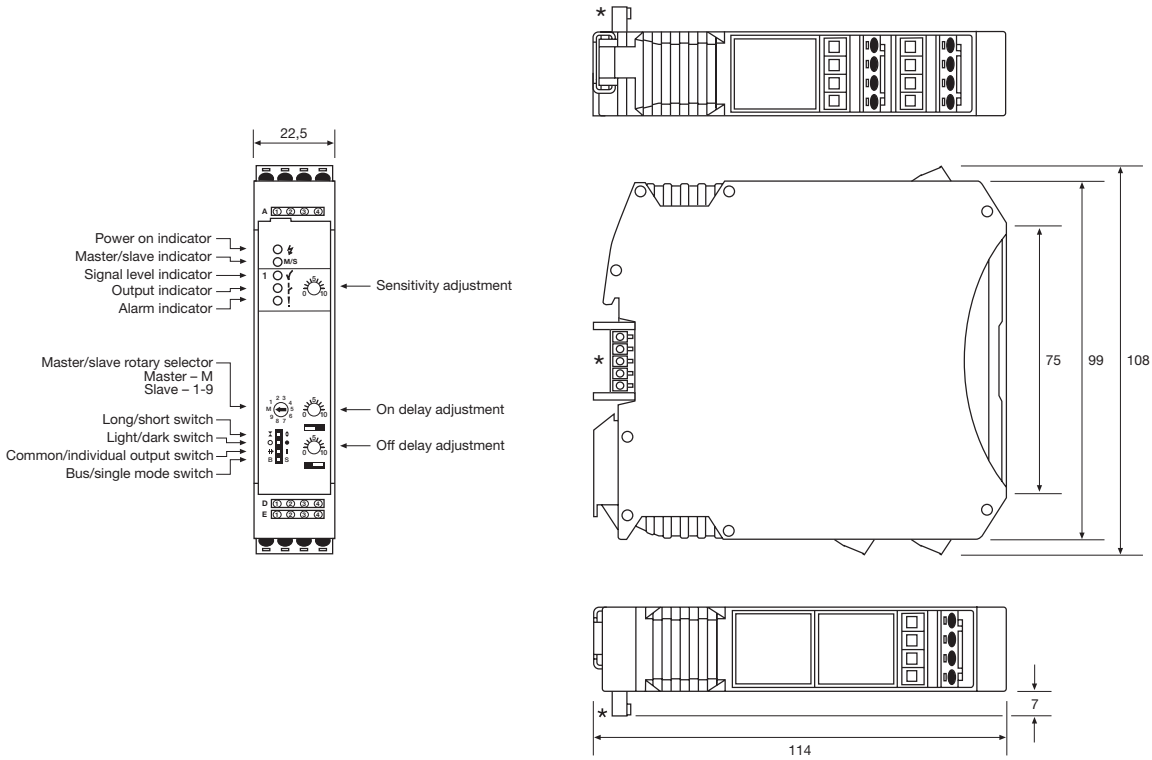

PAB 10 A

* Shown with Bus Rail Connector 22.5 connected in position (to be ordered separately)

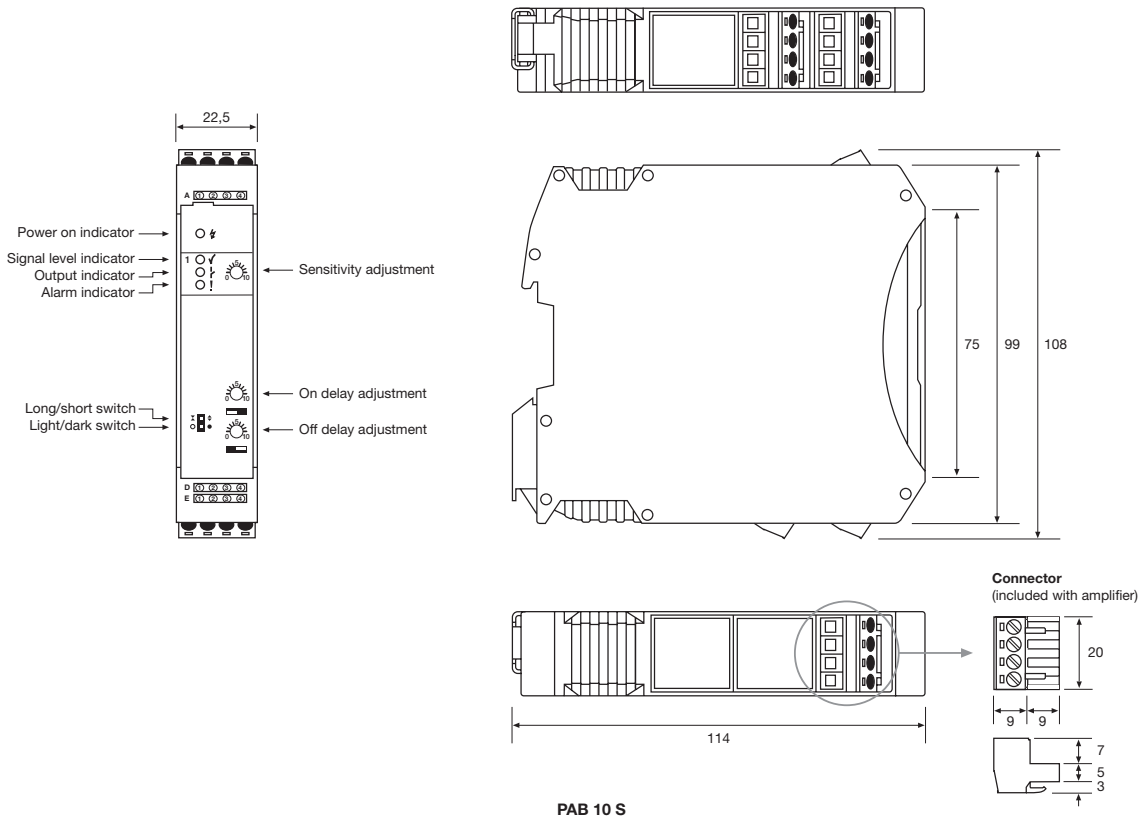

PAB 10 S

(Units in mm)

Telco reserves the right to change specifications without notice.

Description

- Operation mode and max sensing range:
Thru-beam: 0-47 m
Diffuse proximity: 0-2,6 m
- 10-30 V dc and 24 V ac supply voltage
- Manual sensitivity adjustment
- Sensor LED-drive
- Automatic sensor test
- Adjustable on/off time delay
- 2 relay or 2 transistor outputs
- Switch selectable light or dark function
- Switch selectable long or short range
- Test input
- Power, output, alarm, signal level and master/slave address indicators
- Alarm output
- DIN rail mounting with bus function

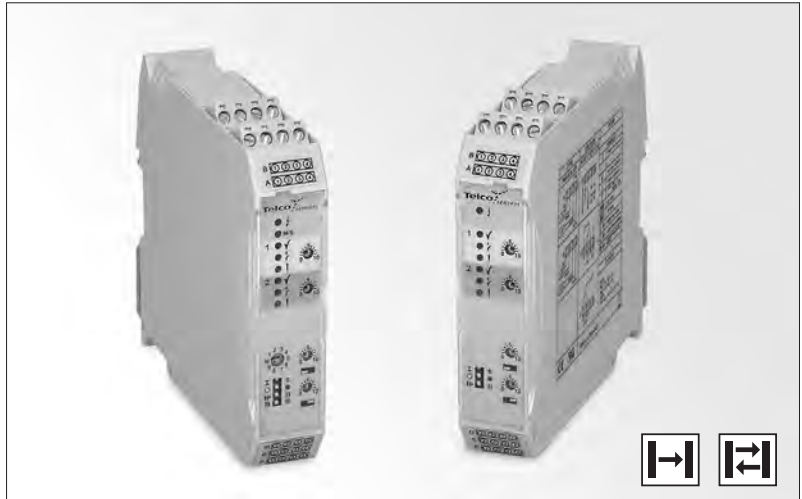

The PAB 20 is a 2-channel, multiplexed, photoelectric amplifier, which is to be used in conjunction with 2 sets of remote transmitters LT and receivers LR from the series 100, 110 and 120. The 2 channels operate independently of each other with their own set of remote transmitter and receiver. The multiplexing function ensures that optical cross talk between channels is prevented.

This amplifier series offers manual sensitivity adjustment, for each individual channel, via an integral potentiometer located on the front panel of the amplifier. The series offers a choice between 2 individual relay or 2 individual transistor outputs, with an adjustable 0-10 sec on/off time delay. Light or dark function and long or short range are switch selectable. The amplifiers from the PAB 20 A series can be connected together with up to 9 amplifiers from the PAB series via a bus rail connector positioned

on the DIN rail, to form a modular master/slave system with up to a total of 29 channels. The bus connection enables communication between the amplifiers, which allows the channels of all the amplifiers to be multiplexed ensuring that optical cross talk between channels is prevented and allows a common output from the amplifier modules. Both the PAB 20 A and PAB 20 S can share power supply via the bus connection.

The amplifier offers a test input, which is used for either disabling or enabling the transmitting power temporarily for test purposes. The amplifier includes an alarm output, which is used to indicate if the signal level is insufficient or if a sensor is faulty. The sensor LED drive powers the optional monitor LEDs available on the remote sensors – output (LT) and power (LR).

Technical Data			
Supply voltage			10-30 V dc or 24 V ac
Voltage tolerance	ac		+/- 10 %
Current consumption			Max. 2,3 W
Output	Relay		250 V ac / 3 A, 120 V ac / 5A
	Transistor		30 V dc / 100 mA
Alarm output	Transistor		30 V dc / 100 mA
Power on indicator			Green LED
Output indicator			Yellow LED
Signal level indicator			Green LED
Alarm indicator			Red / yellow LED
LR sensor failure indicator			Yellow LED
LT sensor failure indicator			Red LED
Master/slave address indicator	PAB 20 A		Green / orange LED
Sensor monitor LED drive			Green monitor LED on receiver indicates 'Power ON' Yellow monitor LED on the transmitter indicates 'PAB output activated'
Hysteresis			Approx. 35 %
Operation frequency	Relay	Short range	17 Hz
		Long range	9 Hz
	Transistor	Short range	28 Hz
		Long range	11 Hz
Response time t_{ON} / t_{OFF}	Relay	Short range	33 ms / 26 ms
		Long range	60 ms / 53 ms
	Transistor	Short range	18 ms / 18 ms
		Long range	45 ms / 45 ms
Delay t_{ON} / t_{OFF}			0-10 sec, adjustable
Housing material			Polyamide

Environmental Data

Temperature, operation	-10 to +50 °C
Temperature, storage	-40 to +80 °C
Sealing class	IP 40
Approvals	CE 

Available Types

Model	Connection	Time Delay	Bus Function	Supply Voltage	10-30 V dc / 24 V ac
				Output	Order Reference
PAB 20 A	Removable screw terminals	On/Off delay 0-10 sec.	Master/Slave communication and Power supply	2 individual relays	PAB 20 A 009
				2 individual NPN	PAB 20 A 109
				2 individual PNP	PAB 20 A 209
PAB 20 S			Power supply	2 individual relays	PAB 20 S 009
				2 individual NPN	PAB 20 S 109
				2 individual PNP	PAB 20 S 209

Note: Remote sensors and bus rail connector to be ordered separately.

Applicable Remote Sensors and Ranges

Series	Thru-beam		Diffuse Proximity	
	Short range	Long range	Short range	Long range
100	4 m	12 m	0,4 m	0,8 m
110	9 m	27 m	0,7 m	1,7 m
120	16 m	47 m	1,2 m	2,6 m

Response Times in Bus Connection

PAB 20 A

Response time	t_{ON} t_{OFF}	Relay		Transistor	
		Short range	Long range	Short range	Long range
		6 ms x (N + 1) + 15 ms	15 ms x (N + 1) + 15 ms	6 ms x (N + 1)	15 ms x (N + 1)
6 ms x (N + 1) + 8 ms	15 ms x (N + 1) + 8 ms	6 ms x (N + 1)	15 ms x (N + 1)		
Operation frequency		83 Hz / (N + 2,9)	33 Hz / (N + 1,8)	83 Hz / (N + 1)	33 Hz / (N + 1)

Note: "N" is equal to the total number of channels connected in the bus connection.

Wiring Diagrams

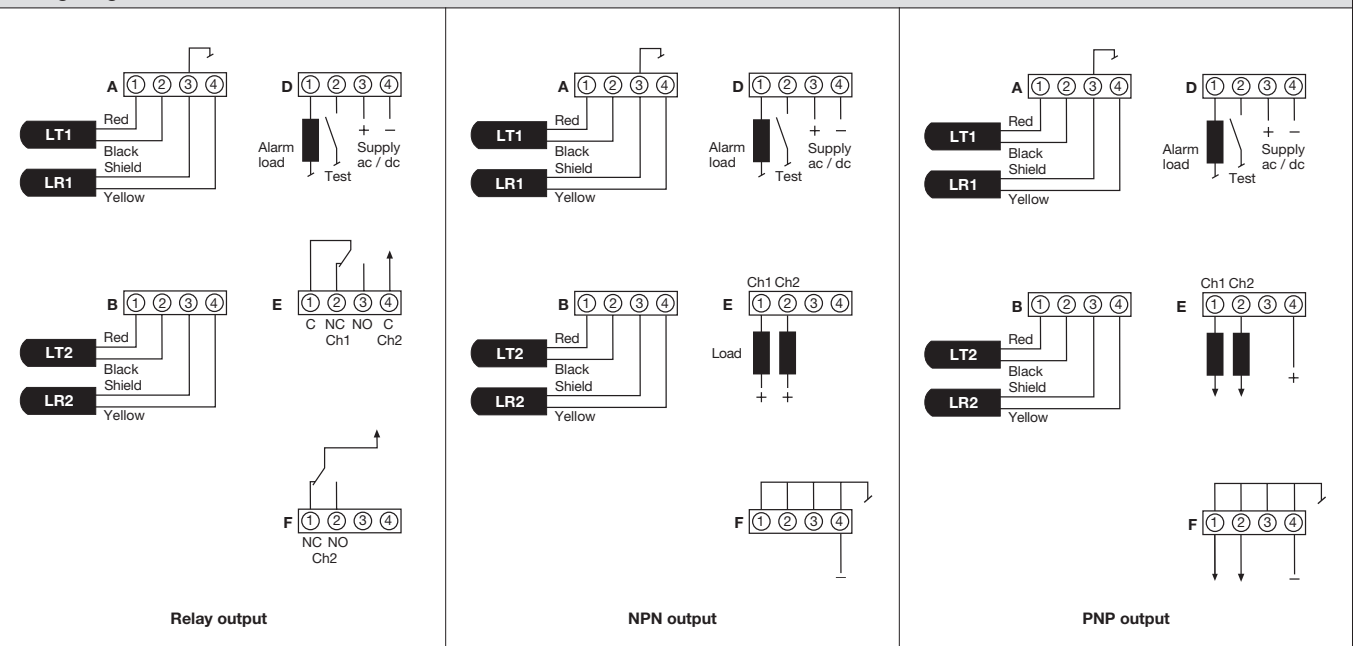

Dimensions and Descriptions

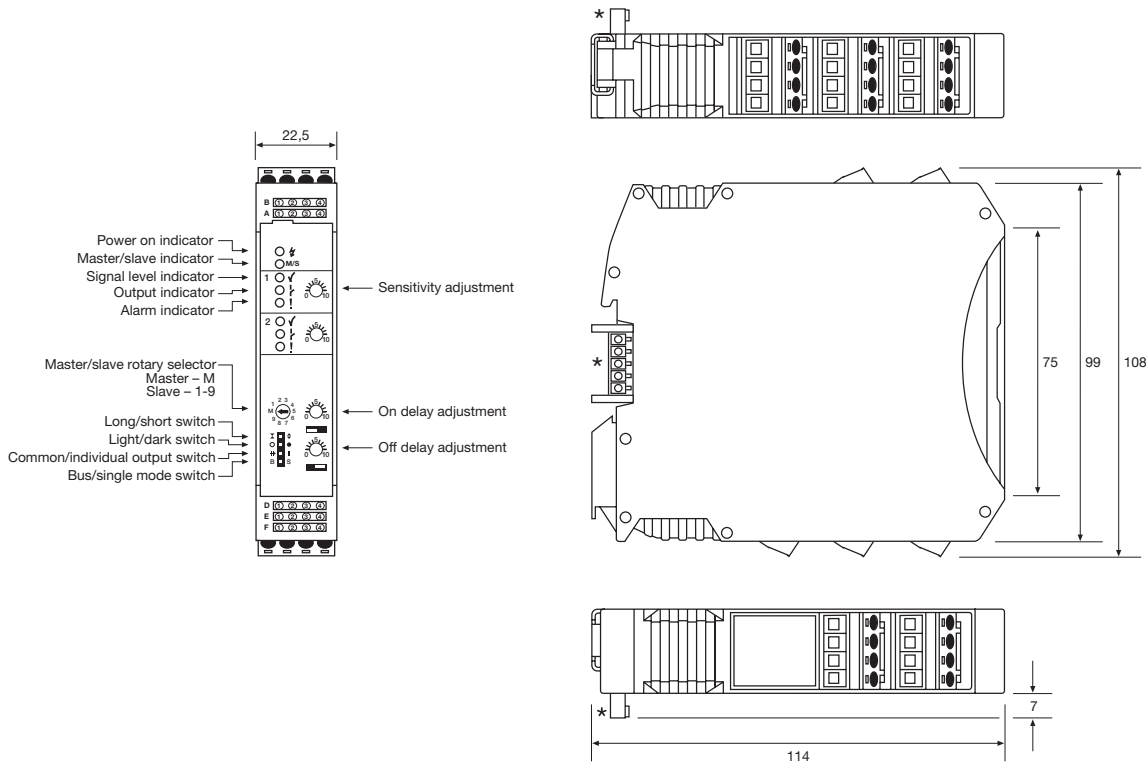

PAB 20 A

* Shown with Bus Rail Connector 22,5 connected in position (to be ordered separately)

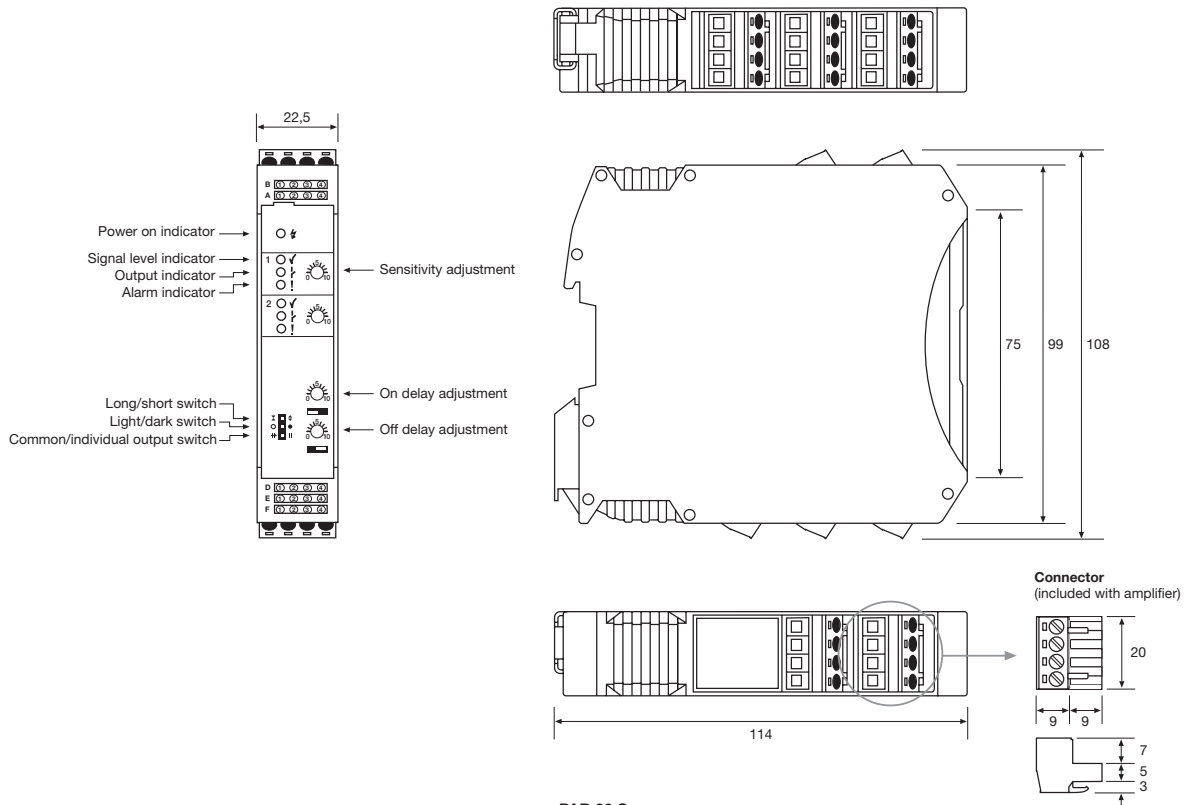

PAB 20 S

(Units in mm)

Telco reserves the right to change specifications without notice.

Description

- Operation mode and max sensing range:
Thru-beam: 0-47 m
Diffuse proximity: 0-2,6 m
- 10-30 V dc and 24 V ac supply voltage
- Manual sensitivity adjustment
- Sensor LED-drive
- Automatic sensor test
- Adjustable on/off time delay
- 3 relay or 3 transistor outputs
- Switch selectable light or dark function
- Switch selectable long or short range
- Test input
- Power, output, alarm, signal level and master/slave address indicators
- Alarm output
- DIN rail mounting with bus function

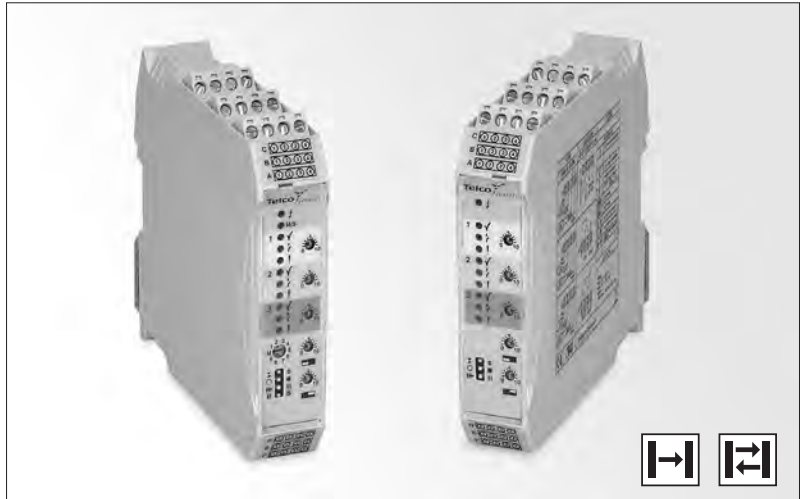

The PAB 30 is a 3-channel, multiplexed, photoelectric amplifier, which is to be used in conjunction with 3 sets of remote transmitters LT and receivers LR from the series 100, 110 and 120. The 3 channels operate independently of each other with their own set of remote transmitter and receiver. The multiplexing function ensures that optical cross talk between channels is prevented.

This amplifier series offers manual sensitivity adjustment, for each individual channel, via an integral potentiometer located on the front panel of the amplifier. The series offers a choice between 3 individual relay or 3 individual transistor outputs, with an adjustable 0-10 sec on/off time delay. Light or dark function and long or short range are switch selectable. The amplifiers from the PAB 30 A series can be connected together with up to 9 amplifiers from the PAB series via a bus rail connector positioned

on the DIN rail, to form a modular master/slave system with up to a total of 30 channels. The bus connection enables communication between the amplifiers, which allows the channels of all the amplifiers to be multiplexed ensuring that optical cross talk between channels is prevented and allows a common output from the amplifier modules. Both the PAB 30 A and PAB 30 S can share power supply via the bus connection.

The amplifier offers a test input, which is used for either disabling or enabling the transmitting power temporarily for test purposes. The amplifier includes an alarm output, which is used to indicate if the signal level is insufficient or if a sensor is faulty. The sensor LED drive powers the optional monitor LEDs available on the remote sensors – output (LT) and power (LR).

Technical Data			
Supply voltage			10-30 V dc or 24 V ac
Voltage tolerance	ac		+/- 10 %
Current consumption			Max. 2,6 W
Output	Relay		250 V ac / 3 A, 120 V ac / 5A
	Transistor		30 V dc / 100 mA
Alarm output	Transistor		30 V dc / 100 mA
Power on indicator			Green LED
Output indicator			Yellow LED
Signal level indicator			Green LED
Alarm indicator			Red / yellow LED
LR sensor failure indicator			Yellow LED
LT sensor failure indicator			Red LED
Master/slave address indicator	PAB 30 A		Green / orange LED
Sensor monitor LED drive			Green monitor LED on receiver indicates 'Power ON' Yellow monitor LED on the transmitter indicates 'PAB output activated'
Hysteresis			Approx. 35 %
Operation frequency	Relay	Short range	14 Hz
		Long range	7 Hz
	Transistor	Short range	21 Hz
		Long range	8 Hz
Response time t _{ON} / t _{OFF}	Relay	Short range	39 ms / 32 ms
		Long range	75 ms / 68 ms
	Transistor	Short range	24 ms / 24 ms
		Long range	60 ms / 60 ms
Delay t _{ON} / t _{OFF}			0-10 sec, adjustable
Housing material			Polyamide

Environmental Data

Temperature, operation	-10 to +50 °C
Temperature, storage	-40 to +80 °C
Sealing class	IP 40
Approvals	CE 

Available Types

Model	Connection	Time Delay	Bus Function	Supply Voltage	10-30 V dc / 24 V ac
				Output	Order Reference
PAB 30 A	Removable screw terminals	On/Off delay 0-10 sec.	Master/Slave communication and Power supply	3 individual relays	PAB 30 A 009
				3 individual NPN	PAB 30 A 109
				3 individual PNP	PAB 30 A 209
PAB 30 S			Power supply	3 individual relays	PAB 30 S 009
				3 individual NPN	PAB 30 S 109
				3 individual PNP	PAB 30 S 209

Note: Remote sensors and bus rail connector to be ordered separately.

Applicable Remote Sensors and Ranges

Series	Thru-beam		Diffuse Proximity	
	Short range	Long range	Short range	Long range
100	4 m	12 m	0,4 m	0,8 m
110	9 m	27 m	0,7 m	1,7 m
120	16 m	47 m	1,2 m	2,6 m

Response Times in Bus Connection

PAB 30 A

Response time	t_{ON} t_{OFF}	Relay		Transistor	
		Short range	Long range	Short range	Long range
		6 ms x (N + 1) + 15 ms	15 ms x (N + 1) + 15 ms	6 ms x (N + 1)	15 ms x (N + 1)
6 ms x (N + 1) + 8 ms	15 ms x (N + 1) + 8 ms	6 ms x (N + 1)	15 ms x (N + 1)		
Operation frequency		83 Hz / (N + 2,9)	33 Hz / (N + 1,8)	83 Hz / (N + 1)	33 Hz / (N + 1)

Note: "N" is equal to the total number of channels connected in the bus connection.

Wiring Diagrams

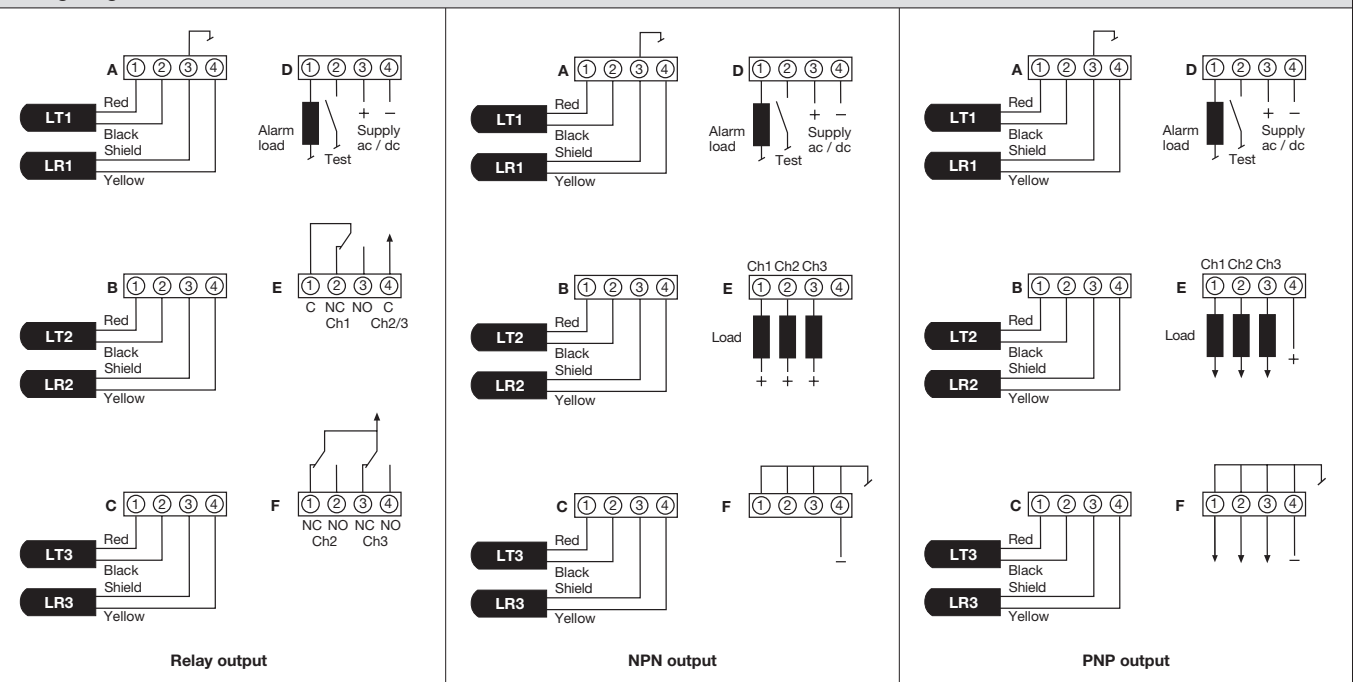

Dimensions and Descriptions

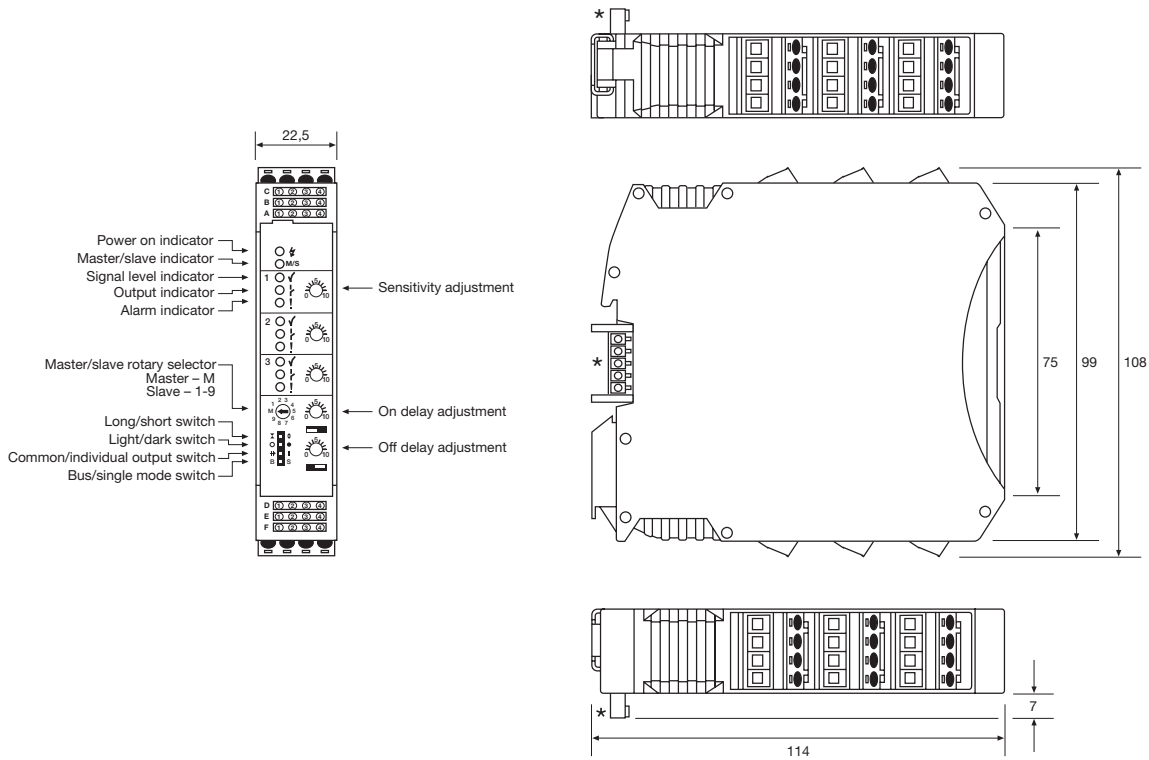

PAB 30 A

* Shown with Bus Rail Connector 22.5 connected in position (to be ordered separately)

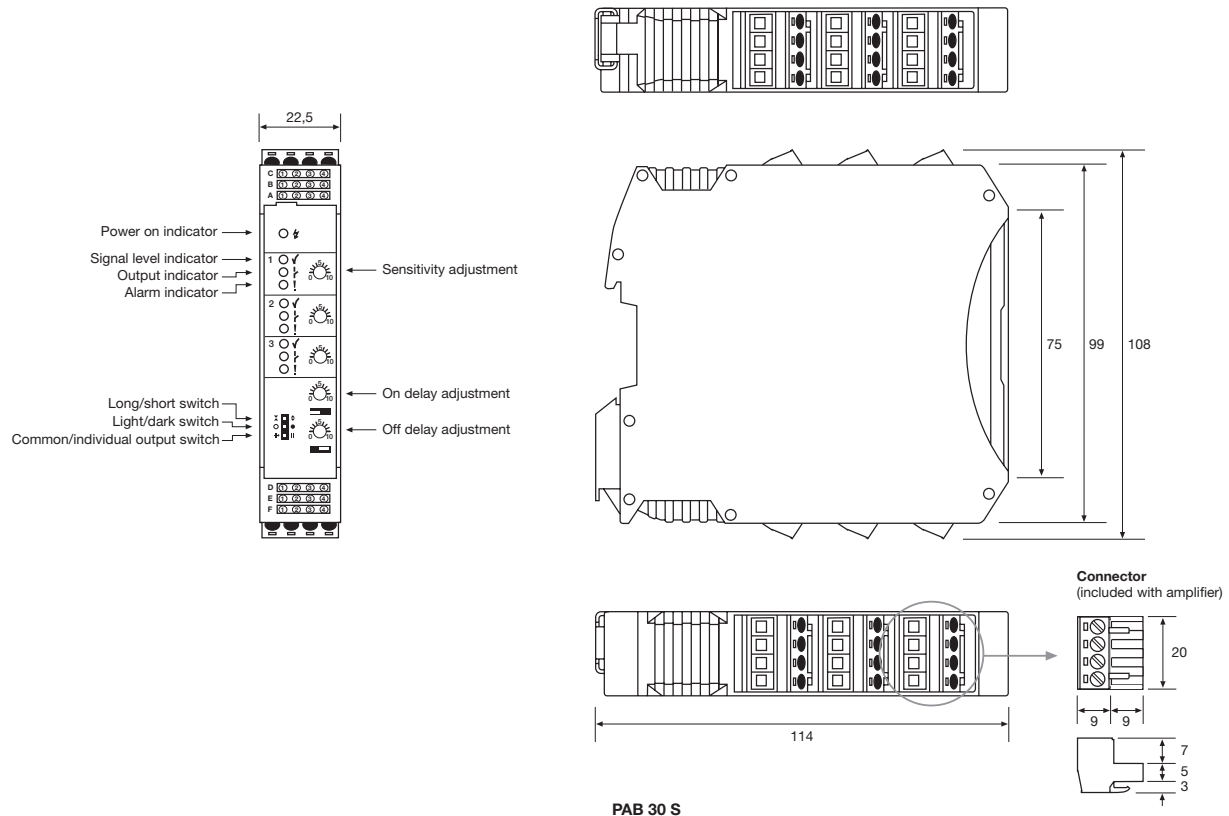

PAB 30 S

(Units in mm)

Telco reserves the right to change specifications without notice.

Description

- Switch mode power supply
- 110-240 V ac supply voltage
- Power and overload indicators
- DIN rail mounting with bus function



The PPB 00 is intended to be used in conjunction with the PAB series, where there is a need for AC supply voltage. This power pack supplies a 24 V dc supply to the photoelectric amplifier bus (PAB) modules connected together via a rail bus connector positioned on the DIN rail. The PPB 00 can power up to 10 PAB modules connected via the bus connection.

The power pack offers a shut down feature for short circuit protection, which ensures that if an external voltage is connected to a PAB module, while connected to the power pack, then the PPB 00 will shut down. This prevents a short circuit between the power pack and the external power supply.

Technical Data

Supply voltage	110-240 V ac
Voltage tolerance	-15 % / +10 %
Current consumption	Max. 60 VA
Supply output voltage	24 V dc
Output current	Max. 1,2 A
Output power	29 W
Power on indicator	Green LED
Overload indicator	Red LED
Housing material	Polyamide

Environmental Data

Temperature, operation	-20 to +55 °C
Temperature, storage	-40 to +80 °C
Sealing class	IP 40
Approvals	CE, RoHS

Available Types

Model	Supply Voltage	110-240 V ac
	Connection	Order Reference
PPB 00	Removable screw terminals	PPB 00 A 909

Note: Bus rail connector to be ordered separately.

Wiring Diagrams

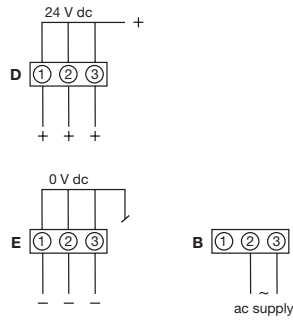

Dimensions and Descriptions

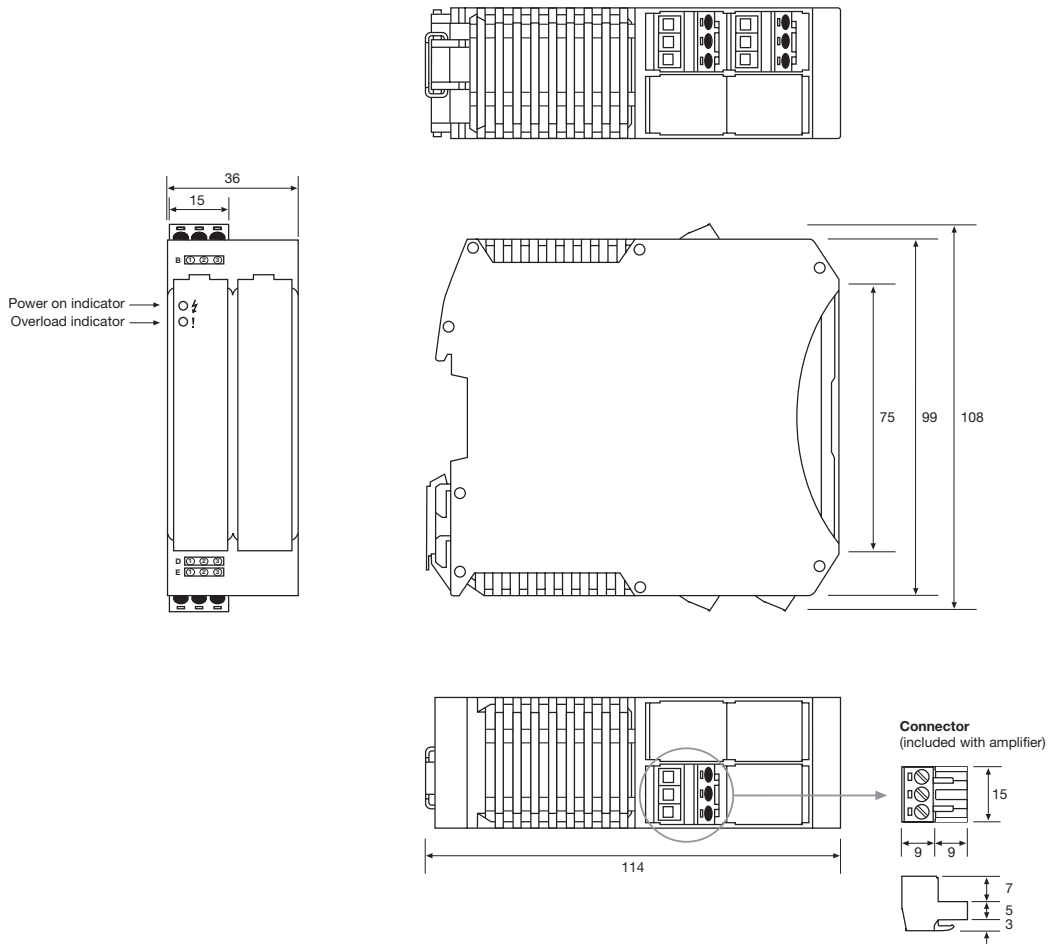

(Units in mm)

Telco reserves the right to change specifications without notice.



SPACEMASTER SERIES

True to its original concept, the SpaceMaster series is diverse in every sense of the word. There is a sensor suitable for every industry out there. And this can easily be justified by the thousands of sites where these infrared sensors operate relentlessly and problem-free day-after-day. That's the only way it should be.



Description

- Operation mode and max sensing range:
Thru-beam: 1-15 m
- Cable or plug connection
- Sensitivity adjustment via control input
- Wide variety of housings
- Power and output indicator
- High tolerance to hostile environments
- 10-30 V dc supply voltage
- 3 wire, NPN or PNP transistor output
- Test input



The 3000 series consists of a self-contained transmitter SMT, and a receiver SMR, which are to be used in thru-beam mode. The complete series is available in a wide range of housings with either cable or plug connection.

The SMR is supplied with a 10-30 V dc supply voltage with a 3 wire, NPN or PNP transistor output with a choice between light or dark function.

The control input in the SMT may be used for either disabling or enabling the transmitting power temporarily for test purpose, multiplexing applications or as a gradual regulation of the transmitting power level.

Both the transmitter and receiver are protected against reverse polarity of power supplies, control input and output signals. The output is also protected against short circuit and inductive loads.

Technical Data						
	SMT			SMR		
	3000C	3012C	3000HC	3x06	3x12	3x15
Supply voltage	10-30 V dc					
Voltage ripple	15 %					
Reverse polarity protected	Yes					
Short circuit protected	-			Yes		
Current consumption	Max. 30 mA			Max. 8 mA		
Maximum output load	-			100 mA		
Maximum residual voltage	-			2,5 V		
Maximum operation frequency	-			> 90 Hz		> 40 Hz
Response time t _{ON} / t _{OFF}	-			< 4 ms / < 6 ms		< 13 ms / < 6 ms
Power on indicator	Green LED			-		
Output indicator	-			Yellow LED		
Hysteresis	-			Approx. 25 %		Approx. 30 %
Light source	Infrared (880 nm)			-		
Opening angle	-			+/- 7°	+/- 3°	+/- 7°
Emission angle	+/- 10°	+/- 5°	+/- 12°	-		
Housing material	Sensor housing	Nickel Plated Brass or Plastic				
	Front lens	Polycarbonate				
Cable, PVC Ø 3,4 mm	3 x 0,14 mm ²					

Environmental Data					
	SMT		SMR		
			3x06	3x12	3x15
Vibration	10-55 Hz, 0,5 mm				
Shock	30 g				
Light immunity, @ 5° incidence	-		35 000 lux	12 000 lux	35 000 lux
Temperature, operation	-20 to +50 °C				
Temperature, storage	-40 to +80 °C				
Sealing class	IP 67				
Approvals	CE				

Available Types

	Type	Control Feature	Output	Connection		5 m cable	3 pin, M8 plug	4 pin, M12 plug	Range
				Housing Material	Housing Type				
Transmitter	3000C	Adjustable range and test input	-	Polycarbonate	Ø10	SMT 3000C AP 5	SMT 3000C AP T3	-	1-6 m
					M12 x 1	SMT 3000C TP 5	SMT 3000C TP T3	-	
				Nickel Plated Brass		SMT 3000C TB 5	SMT 3000C TB T3	SMT 3000C TB J	
				Polyester	□ 9,5 x 11,5	SMT 3000C SG 5 ¹	SMT 3000C SG T3	-	
				Polycarbonate	Ø12,7 Snap	SMT 3000C S30 5 ¹	-	-	
			M18 x 1		SMT 3000C TP18 5	-	SMT 3000C TP18 J		

Receiver	3006	-	NPN LO (NC)	Polycarbonate	Ø10	SMR 3006 AP 5	SMR 3006 AP T3	-	6 m
				Nickel Plated Brass	M12 x 1	SMR 3006 TP 5	SMR 3006 TP T3	-	
						SMR 3006 TB 5	SMR 3006 TB T3	SMR 3006 TB J	
				Polyester	□ 9,5 x 11,5	SMR 3006 SG 5 ¹	SMR 3006 SG T3	-	
				Polycarbonate	Ø12,7 Snap	SMR 3006 S30 5 ¹	-	-	
	M18 x 1		SMR 3006 TP18 5		-	SMR 3006 TP18 J			
	3106		NPN DO (NO)	Polycarbonate	Ø10	SMR 3106 AP 5	SMR 3106 AP T3	-	
				Nickel Plated Brass	M12 x 1	SMR 3106 TP 5	SMR 3106 TP T3	-	
					SMR 3106 TB 5	SMR 3106 TB T3	SMR 3106 TB J		
			Polyester	□ 9,5 x 11,5	SMR 3106 SG 5 ¹	SMR 3106 SG T3	-		
			Polycarbonate	Ø12,7 Snap	SMR 3106 S30 5 ¹	-	-		
	M18 x 1			SMR 3106 TP18 5	-	SMR 3106 TP18 J			
	3206		PNP LO (NC)	Polycarbonate	Ø10	SMR 3206 AP 5	SMR 3206 AP T3	-	
				Nickel Plated Brass	M12 x 1	SMR 3206 TP 5	SMR 3206 TP T3	-	
					SMR 3206 TB 5	SMR 3206 TB T3	SMR 3206 TB J		
			Polyester	□ 9,5 x 11,5	SMR 3206 SG 5 ¹	SMR 3206 SG T3	-		
Polycarbonate		Ø12,7 Snap	SMR 3206 S30 5 ¹	-	-				
	M18 x 1	SMR 3206 TP18 5	-	SMR 3206 TP18 J					
3306	PNP DO (NO)	Polycarbonate	Ø10	SMR 3306 AP 5	SMR 3306 AP T3	-			
		Nickel Plated Brass	M12 x 1	SMR 3306 TP 5	SMR 3306 TP T3	-			
			SMR 3306 TB 5	SMR 3306 TB T3	SMR 3306 TB J				
	Polyester	□ 9,5 x 11,5	SMR 3306 SG 5 ¹	SMR 3306 SG T3	-				
	Polycarbonate	Ø12,7 Snap	SMR 3306 S30 5 ¹	-	-				
M18 x 1		SMR 3306 TP18 5	-	SMR 3306 TP18 J					

Note: Sensors marked ¹ do not have power on or output indicators incorporated.

Transmitter	3012C	Adjustable range and test input	-	Polycarbonate	Ø10	SMT 3012C AP 5	SMT 3012C AP T3	-	2-12 m
					M12 x 1	SMT 3012C TP 5	SMT 3012C TP T3	-	
				Nickel Plated Brass		SMT 3012C TB 5	SMT 3012C TB T3	SMT 3012C TB J	

Receiver	3012	-	NPN LO (NC)	Polycarbonate	Ø10	SMR 3012 AP 5	SMR 3012 AP T3	-	12 m
				Nickel Plated Brass	M12 x 1	SMR 3012 TP 5	SMR 3012 TP T3	-	
			SMR 3012 TB 5		SMR 3012 TB T3	SMR 3012 TB J			
	3112		NPN DO (NO)	Polycarbonate	Ø10	SMR 3112 AP 5	SMR 3112 AP T3	-	
				Nickel Plated Brass	M12 x 1	SMR 3112 TP 5	SMR 3112 TP T3	-	
			SMR 3112 TB 5		SMR 3112 TB T3	SMR 3112 TB J			
	3212		PNP LO (NC)	Polycarbonate	Ø10	SMR 3212 AP 5	SMR 3212 AP T3	-	
				Nickel Plated Brass	M12 x 1	SMR 3212 TP 5	SMR 3212 TP T3	-	
			SMR 3212 TB 5		SMR 3212 TB T3	SMR 3212 TB J			
	3312		PNP DO (NO)	Polycarbonate	Ø10	SMR 3312 AP 5	SMR 3312 AP T3	-	
Nickel Plated Brass		M12 x 1		SMR 3312 TP 5	SMR 3312 TP T3	-			
		SMR 3312 TB 5	SMR 3312 TB T3	SMR 3312 TB J					

Available Types

	Type	Control Feature	Output	Connection		5 m cable	3 pin, M8 plug	4 pin, M12 plug	Range
				Housing Material	Housing Type				
Transmitter	3000HC	Adjustable range and test input	-	Polycarbonate	Ø10	SMT 3000HC AP 5	SMT 3000HC AP T3	-	2-15 m
					M12 x 1	SMT 3000HC TP 5	SMT 3000HC TP T3	-	
				Nickel Plated Brass		SMT 3000HC TB 5	SMT 3000HC TB T3	SMT 3000HC TB J	
				Polyester	□ 9,5 x 11,5	SMT 3000HC SG 5 ¹	SMT 3000HC SG T3	-	
				Polycarbonate	Ø12,7 Snap	SMT 3000HC S30 5 ¹	-	-	
			M18 x 1		SMT 3000HC TP18 5	-	SMT 3000HC TP18 J		

Receiver	3015	-	NPN LO (NC)	Polycarbonate	Ø10	SMR 3015 AP 5	SMR 3015 AP T3	-	15 m
				Nickel Plated Brass	M12 x 1	SMR 3015 TP 5	SMR 3015 TP T3	-	
					Polyester	□ 9,5 x 11,5	SMR 3015 TB 5	SMR 3015 TB T3	
				Polycarbonate	Ø12,7 Snap	SMR 3015 SG 5 ¹	SMR 3015 SG T3	-	
					M18 x 1	SMR 3015 S30 5 ¹	-	-	
	3115	-	NPN DO (NO)	Polycarbonate	Ø10	SMR 3115 AP 5	SMR 3115 AP T3	-	
				Nickel Plated Brass	M12 x 1	SMR 3115 TP 5	SMR 3115 TP T3	-	
					Polyester	□ 9,5 x 11,5	SMR 3115 TB 5	SMR 3115 TB T3	
				Polycarbonate	Ø12,7 Snap	SMR 3115 SG 5 ¹	SMR 3115 SG T3	-	
					M18 x 1	SMR 3115 S30 5 ¹	-	-	
	3215	-	PNP LO (NC)	Polycarbonate	Ø10	SMR 3215 AP 5	SMR 3215 AP T3	-	
				Nickel Plated Brass	M12 x 1	SMR 3215 TP 5	SMR 3215 TP T3	-	
					Polyester	□ 9,5 x 11,5	SMR 3215 TB 5	SMR 3215 TB T3	
				Polycarbonate	Ø12,7 Snap	SMR 3215 SG 5 ¹	SMR 3215 SG T3	-	
					M18 x 1	SMR 3215 S30 5 ¹	-	-	
	3315	-	PNP DO (NO)	Polycarbonate	Ø10	SMR 3315 AP 5	SMR 3315 AP T3	-	
				Nickel Plated Brass	M12 x 1	SMR 3315 TP 5	SMR 3315 TP T3	-	
					Polyester	□ 9,5 x 11,5	SMR 3315 TB 5	SMR 3315 TB T3	
				Polycarbonate	Ø12,7 Snap	SMR 3315 SG 5 ¹	SMR 3315 SG T3	-	
					M18 x 1	SMR 3315 S30 5 ¹	-	-	

Note: Sensors marked ¹ do not have power on or output indicators incorporated.

Connections

	Cable	M8 Plug / Cable	M12 Plug / Cable
Supply +	Brown	Pin 1 / Brown	Pin 1 / Brown
Supply -	Blue	Pin 3 / Blue	Pin 3 / Blue
SMT control input	Black	Pin 4 / Black	Pin 4 / Black
SMR output	Black	Pin 4 / Black	Pin 4 / Black

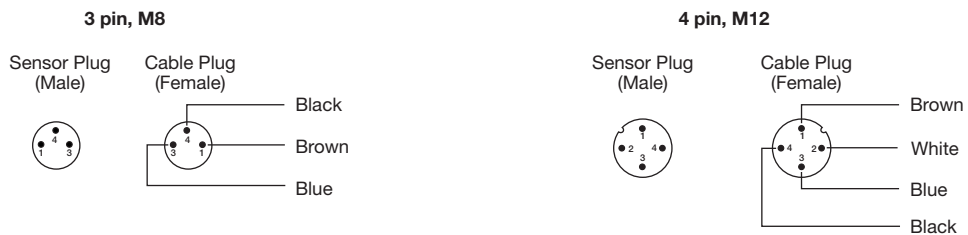

Refer to page 161 for extension cables

Wiring Diagrams

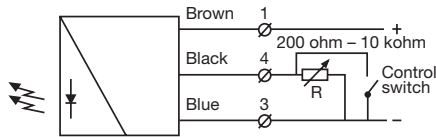

SMT 30xxC
Variable range and ON/OFF switch
for transmitting power

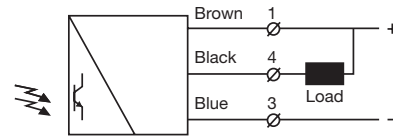

SMR 30xx / 31xx

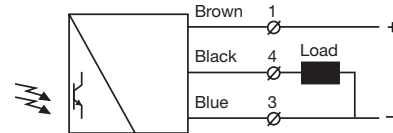

SMR 32xx / 33xx

Dimensions and Descriptions

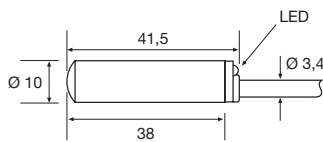

AP 5

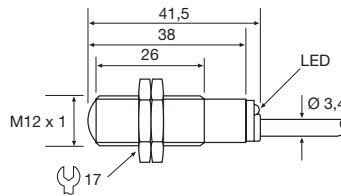

TP/TB 5

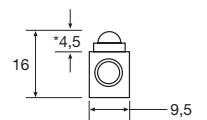

SG 5

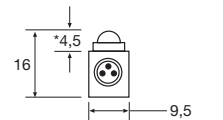

SG T3

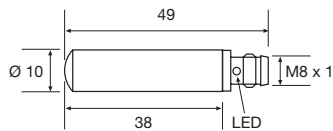

AP T3

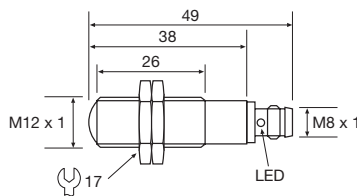

TP/TB T3

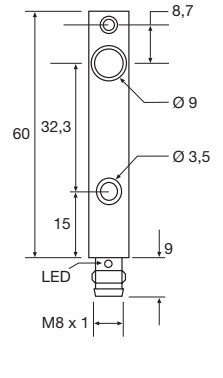
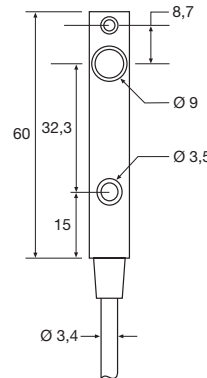

* SMT 3000C: 2,7

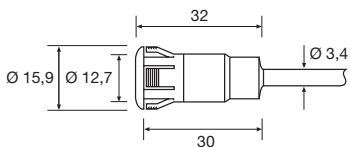

S30 5

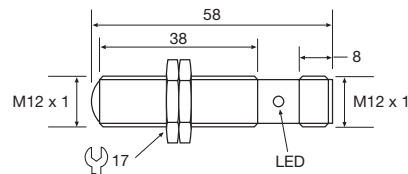

TB J

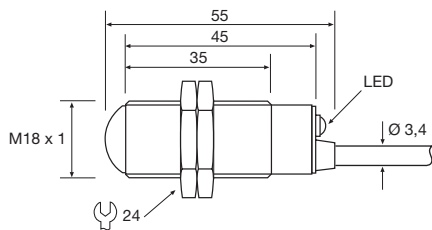

TP18 5

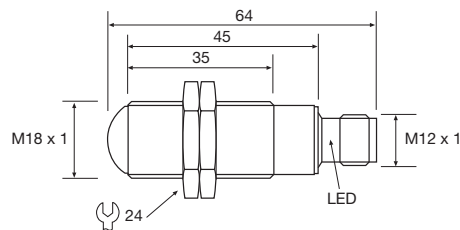

TP18 J

(Units in mm)

Sensing Characteristics

Parallel Displacement

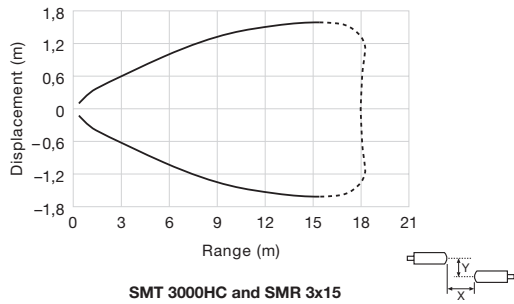
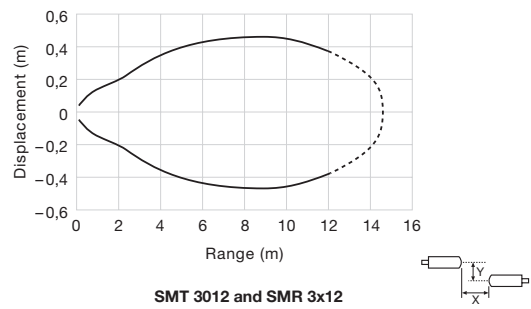
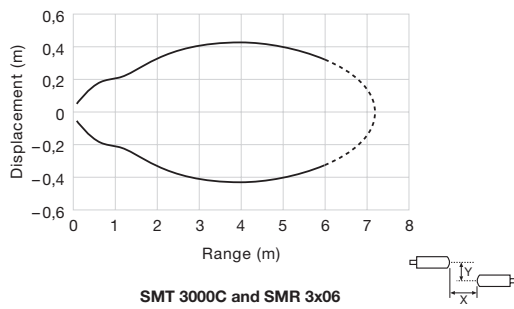

Angular Displacement

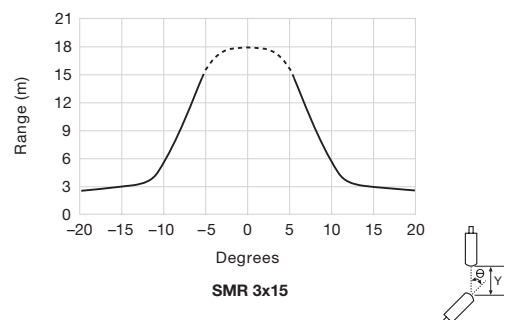
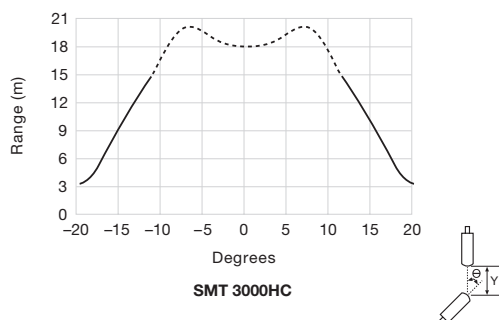
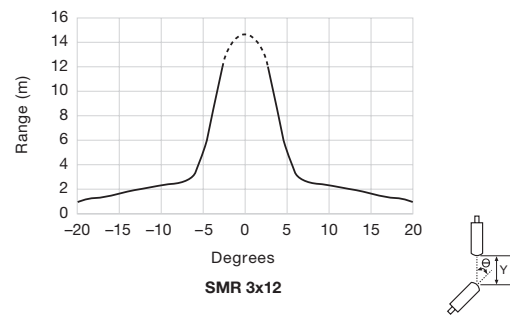
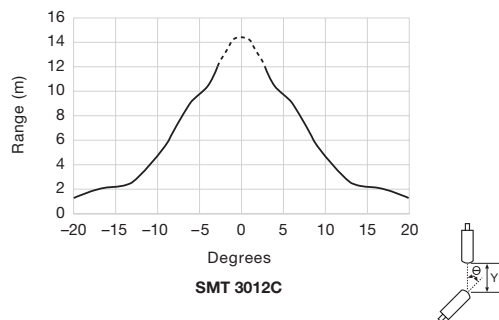
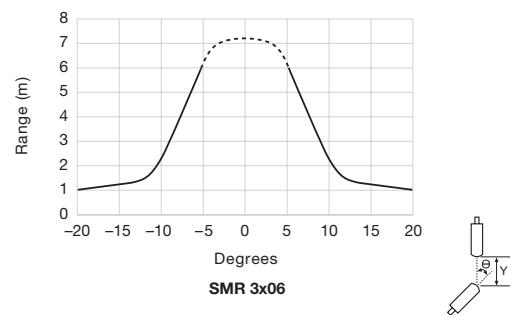
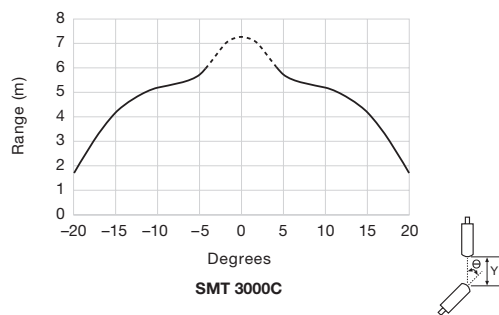

Telco reserves the right to change specifications without notice.

Description

- Operation mode and max sensing range:
Thru-beam: 1-6 m
- Cable or plug connection
- Sensitivity adjustment via control input
- Wide variety of housings
- Power and output indicators
- High tolerance to hostile environments
- 10-32 V dc supply voltage
- 3 wire, NPN or PNP output or
4 wire, NPN/PNP opto isolated output
- 5 or 0,5 ms response time
- Low current consumption
- Test input



The 6000 series consists of a self-contained transmitter SMT, and a receiver SMR, which are to be used in thru-beam mode. The complete series is available in a wide range of housings with either plug or cable connection.

The SMR is supplied with a 10-32 V dc supply voltage with either a 3 wire, NPN or PNP or as a 4 wire, NPN/PNP opto-isolated transistor output with a choice between light or dark function. The SMR is available with either a 0,5 ms response time and a 2 metre range, or with a 5 ms

response time and a 6 metre range. The control input in the SMT may be used for either disabling or enabling the transmitting power temporarily for test purpose, multiplexing applications or as a gradual regulation of the transmitting power level.

Both the transmitter and receiver are protected against reverse polarity of power supplies, control input and output signals. The output is also protected against short circuit and inductive loads.

Technical Data				
		SMT	SMR	
			6x02	6x06
Supply voltage		10-32 V dc		
Voltage ripple		15 %		
Reverse polarity protected		Yes		
Short circuit protected		-	Yes	
Current consumption		max. 320 mW		
Maximum output load		-	100 mA	
Maximum residual voltage		-	2,5 V	
Maximum operation frequency		-	1000 Hz	100 Hz
Response time t _{ON} / t _{OFF}		-	0,5 ms / 0,5 ms	5 ms / 5 ms
Power on indicator		Green LED	-	
Output indicator		-	Yellow LED	
Hysteresis		-	Approx. 30%	
Light source		Infrared (880 nm)	-	
Opening angle		-	+/- 6°	
Emission angle		+/- 10°	-	
Housing material	Sensor housing	Stainless Steel (AISI 316 / 1.4401) or Plastic		
	Front lens	Polycarbonate		
Cable, PVC Ø 4,0 mm		3 x 0,14 mm ²		

Environmental Data

	SMT	SMR
Vibration		10-55 Hz, 0,5 mm
Shock		30 g
Light immunity, @ 5° incidence	-	> 50 000 lux
Temperature, operation		-20 to +60 °C
Temperature, storage		-40 to +80 °C
Sealing class		IP 67
Approvals		CE

Available Types

	Type	Control Feature	Output	Connection		5 m cable	3 pin, M8 plug	4 pin, M8 plug	4 pin, M12 plug	Range	
				Housing Material	Housing Type						Order Reference
Transmitter	6000	Adjustable range and test input	-	Polycarbonate	Ø10	SMT 6000 AP 5	SMT 6000 AP T3	-	-	1-6 m	
					M12 x 1	SMT 6000 TP 5	SMT 6000 TP T3	-	-		
				Stainless Steel	Ø10	SMT 6000 AS 5	SMT 6000 AS T3	SMT 6000 AS T4	-		-
					M12 x 1	SMT 6000 TS 5	SMT 6000 TS T3	SMT 6000 TS T4	SMT 6000 TS J		-
Polyester	□ 9,5 x 11,5	SMT 6000 SG 5¹	SMT 6000 SG T3	-	-	-					

Receiver	6006	-	NPN LO (NC)	Polycarbonate	Ø10	SMR 6006 AP 5	SMR 6006 AP T3	-	-	6 m
					M12 x 1	SMR 6006 TP 5	SMR 6006 TP T3	-	-	
				Stainless Steel	Ø10	SMR 6006 AS 5	SMR 6006 AS T3	-	-	
					M12 x 1	SMR 6006 TS 5	SMR 6006 TS T3	-	SMR 6006 TS J	
	Polyester	□ 9,5 x 11,5	SMR 6006 SG 5¹	SMR 6006 SG T3	-	-				
	6106	-	NPN DO (NO)	Polycarbonate	Ø10	SMR 6106 AP 5	SMR 6106 AP T3	-	-	
					M12 x 1	SMR 6106 TP 5	SMR 6106 TP T3	-	-	
				Stainless Steel	Ø10	SMR 6106 AS 5	SMR 6106 AS T3	-	-	
					M12 x 1	SMR 6106 TS 5	SMR 6106 TS T3	-	SMR 6106 TS J	
	Polyester	□ 9,5 x 11,5	SMR 6106 SG 5¹	SMR 6106 SG T3	-	-				
	6206	-	PNP LO (NC)	Polycarbonate	Ø10	SMR 6206 AP 5	SMR 6206 AP T3	-	-	
					M12 x 1	SMR 6206 TP 5	SMR 6206 TP T3	-	-	
				Stainless Steel	Ø10	SMR 6206 AS 5	SMR 6206 AS T3	-	-	
					M12 x 1	SMR 6206 TS 5	SMR 6206 TS T3	-	SMR 6206 TS J	
	Polyester	□ 9,5 x 11,5	SMR 6206 SG 5¹	SMR 6206 SG T3	-	-				
	6306	-	PNP DO (NO)	Polycarbonate	Ø10	SMR 6306 AP 5	SMR 6306 AP T3	-	-	
					M12 x 1	SMR 6306 TP 5	SMR 6306 TP T3	-	-	
				Stainless Steel	Ø10	SMR 6306 AS 5	SMR 6306 AS T3	-	-	
					M12 x 1	SMR 6306 TS 5	SMR 6306 TS T3	-	SMR 6306 TS J	
	Polyester	□ 9,5 x 11,5	SMR 6306 SG 5¹	SMR 6306 SG T3	-	-				
6406	-	NPN/PNP DO (NO)	Stainless Steel	Ø10	-	-	SMR 6406 AS T4	-		
				M12 x 1	-	-	SMR 6406 TS T4	SMR 6406 TS J		
6506	-	NPN/PNP LO (NC)	Stainless Steel	Ø10	-	-	SMR 6506 AS T4	-		
				M12 x 1	-	-	SMR 6506 TS T4	SMR 6506 TS J		

Note: Sensors marked ¹ do not have power on or output indicators incorporated.

Available Types

	Type	Control Feature	Output	Connection		5m cable	3 pin, M8 plug	4 pin, M8 plug	4 pin, M12 plug	Range	
				Housing Material	Housing Type						Order Reference
Receiver	6002		NPN LO (NC)	Polycarbonate	Ø10	SMR 6002 AP 5	SMR 6002 AP T3	-	-	2 m	
					M12 x 1	SMR 6002 TP 5	SMR 6002 TP T3	-	-		
					Stainless Steel	Ø10	SMR 6002 AS 5	SMR 6002 AS T3	-		-
						M12 x 1	SMR 6002 TS 5	SMR 6002 TS T3	-		SMR 6002 TS J
				Polyester	□ 9,5 x 11,5	SMR 6002 SG 5 ¹	SMR 6002 SG T3	-	-		
					Polycarbonate	Ø10	SMR 6102 AP 5	SMR 6102 AP T3	-		-
						M12 x 1	SMR 6102 TP 5	SMR 6102 TP T3	-		-
						Stainless Steel	Ø10	SMR 6102 AS 5	SMR 6102 AS T3		-
	M12 x 1	SMR 6102 TS 5	SMR 6102 TS T3	-			SMR 6102 TS J				
	Polyester	□ 9,5 x 11,5	SMR 6102 SG 5 ¹	SMR 6102 SG T3	-	-					
		Polycarbonate	Ø10	SMR 6202 AP 5	SMR 6202 AP T3	-	-				
			M12 x 1	SMR 6202 TP 5	SMR 6202 TP T3	-	-				
			Stainless Steel	Ø10	SMR 6202 AS 5	SMR 6202 AS T3	-	-			
	M12 x 1			SMR 6202 TS 5	SMR 6202 TS T3	-	SMR 6202 TS J				
	Polyester	□ 9,5 x 11,5	SMR 6202 SG 5 ¹	SMR 6202 SG T3	-	-					
		Polycarbonate	Ø10	SMR 6302 AP 5	SMR 6302 AP T3	-	-				
			M12 x 1	SMR 6302 TP 5	SMR 6302 TP T3	-	-				
			Stainless Steel	Ø10	SMR 6302 AS 5	SMR 6302 AS T3	-	-			
	M12 x 1			SMR 6302 TS 5	SMR 6302 TS T3	-	SMR 6302 TS J				
	Polyester	□ 9,5 x 11,5	SMR 6302 SG 5 ¹	SMR 6302 SG T3	-	-					
Polycarbonate		Ø10	SMR 6402 AP 5	SMR 6402 AP T3	-	-					
		M12 x 1	SMR 6402 TP 5	SMR 6402 TP T3	-	-					
Stainless Steel		Ø10	SMR 6402 AS 5	SMR 6402 AS T3	-	-					
	M12 x 1	SMR 6402 TS 5	SMR 6402 TS T3	-	SMR 6402 TS J						
Polyester	□ 9,5 x 11,5	SMR 6402 SG 5 ¹	SMR 6402 SG T3	-	-						
	Polycarbonate	Ø10	SMR 6502 AP 5	SMR 6502 AP T3	-	-					
		M12 x 1	SMR 6502 TP 5	SMR 6502 TP T3	-	-					
	Stainless Steel	Ø10	SMR 6502 AS 5	SMR 6502 AS T3	-	-					
M12 x 1		SMR 6502 TS 5	SMR 6502 TS T3	-	SMR 6502 TS J						

Note: Sensors marked ¹ do not have power on or output indicators incorporated.

Connections

	Cable	M8 Plug / Cable	M12 Plug / Cable
Supply +	Brown	Pin 1 / Brown	Pin 1 / Brown
Supply -	Blue	Pin 3 / Blue	Pin 3 / Blue
SMT control input	Black	Pin 4 / Black	Pin 4 / Black
SMR output	Black	Pin 4 / Black	Pin 4 / Black
SMR output	White	Pin 2 / White	Pin 2 / White

3 pin, M8

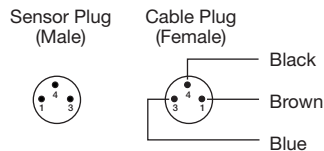

4 pin, M8

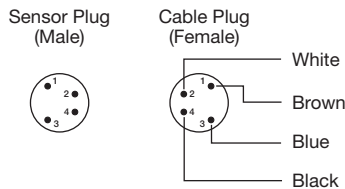

4 pin, M12

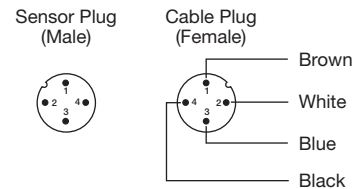

Refer to page 161 for extension cables

Wiring Diagrams

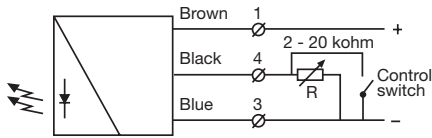

SMT 6000 1-6 m
Variable range and ON/OFF switch for transmitting power

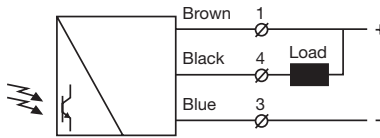

SMR 600x / 610x

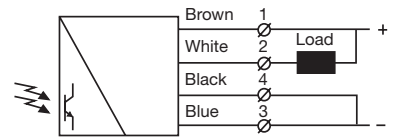

SMR 640x / 650x (load as NPN)

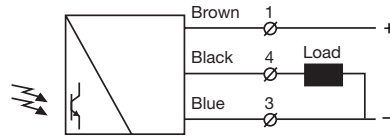

SMR 620x / 630x

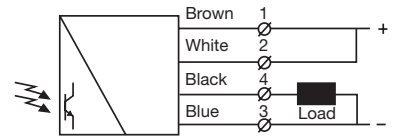

SMR 640x / 650x (load as PNP)

Dimensions and Descriptions

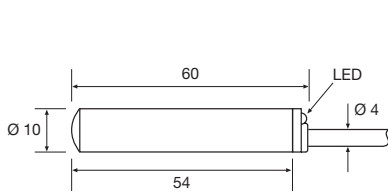

AP/AS 5

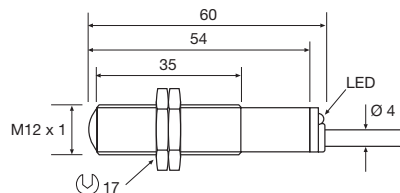

TP/TS 5

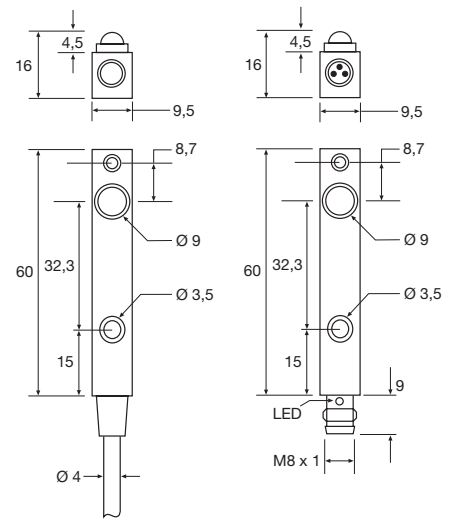

SG 5

SG T3

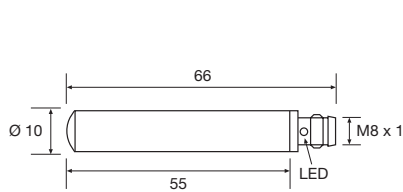

AP/AS T3/T4

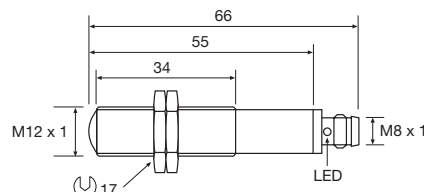

TP/TS T3/T4

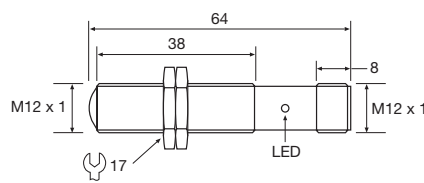

TS J

(Units in mm)

Sensing Characteristics

Parallel Displacement

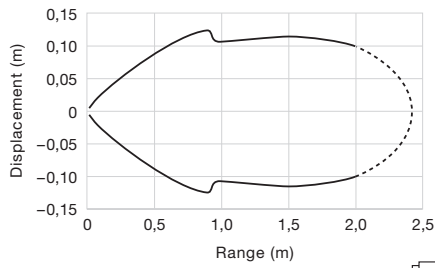

SMT 6000 and SMR 6x02

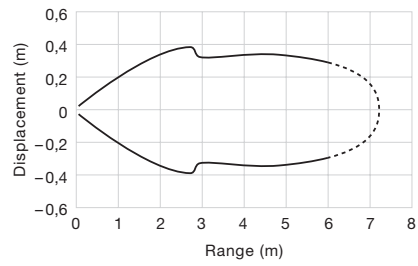
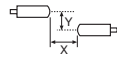

SMT 6000 and SMR 6x06

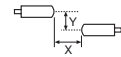

Angular Displacement

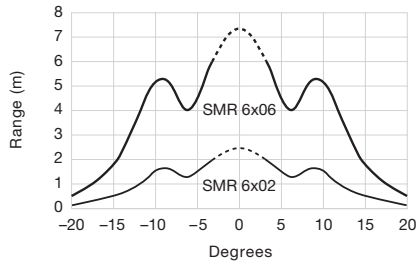

SMT 6000

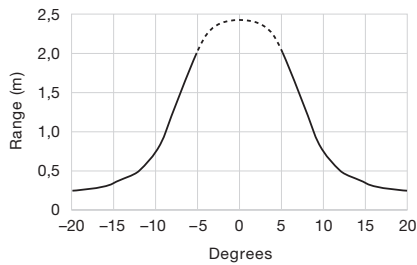
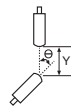

SMR 6x02

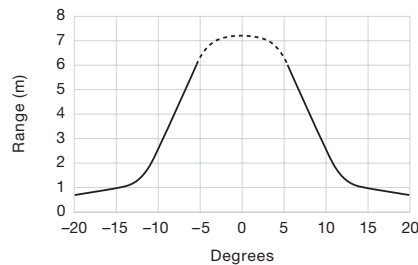
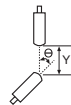

SMR 6x06

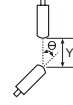

Telco reserves the right to change specifications without notice.

Description

- Operation mode and max sensing range:
Thru-beam: 0-20 m
Diffuse proximity: 0-0,5 m
Retro reflective: 0-3 m
Fibre: Dependent on fibre optic
- Cable or plug connection
- Sensitivity adjustment via potentiometer
- Switch selectable light or dark function
- Power and output indicators
- High tolerance to hostile environments
- 10-30 V dc supply voltage
- 4 wire, NPN/PNP transistor output or
 4 wire, ambivalent PNP/PNP transistor output
- Test input



The 7000 series consists of a self-contained transmitter SMT, and a receiver SMR which are to be used in thru-beam mode, an SMP for diffuse proximity, SMRR for retro reflective and an SMPF for use with fibre optic cables. All are offered with sensitivity adjustment via integral potentiometer with either cable or plug connection.

is available with either a 0.5 ms response time and a 7 metre range or with a 2 ms response time and a 20 metre range. The control input in the SMT is intended to be used for disabling or enabling the transmitting power temporarily for test purpose or for multiplexing applications.

The complete series is available either as 4 wire, NPN/PNP transistor output or 4 wire ambivalent PNP/PNP output with a 10-30 V dc supply voltage, both offering switch selectable light or dark function. The SMR

The complete series is protected against reverse polarity of power supplies, control input and output signals. The output is protected against short circuit and inductive loads.

Technical Data

	SMT	SMR		SMP	SMPF	SMRR
		7x07	7x20			
Supply voltage	10-30 V dc					
Voltage ripple	15 %					
Reverse polarity protected	Yes					
Short circuit protected	-	Yes				
Current consumption	25 mA	15 mA		20 mA		
Maximum output load	-	120 mA / 30 V dc				
Maximum residual voltage	-	2 V				
Maximum operation frequency	-	1000 Hz	250 Hz			
Response time t _{ON} / t _{OFF}	-	0,5 ms / 0,5 ms	2 ms / 2 ms			
Power on indicator	Green LED					
Output indicator	-	Yellow LED				
Hysteresis	-	Approx. 15-20 %		Approx. 3-10 %		
Light source	Infrared (880 nm)	-		Infrared (880 nm)		
Opening angle	-	+/- 6°		+/- 4°		+/- 3,5°
Emission angle	+/- 2°	-				
Housing material	Sensor housing	Stainless Steel (AISI 316 / 1.4401) or Polycarbonate				
	Front lens	Polycarbonate				
Cable, PVC Ø 4,0 mm	3 x 0,14 mm ²	4 x 0,14 mm ²				

Environmental Data

	SMT	SMR		SMP	SMPF	SMRR
		7x07	7x20			
Vibration	10-55 Hz, 0,5 mm					
Shock	30 g					
Light immunity	@ 5° incidence	-	> 20 000 lux	-		
	@ 15° incidence	-	-	> 40 000 lux	> 25 000 lux	
Temperature, operation	-20 to +60 °C					
Temperature, storage	-40 to +80 °C					
Sealing class	IP 67					
Approvals	CE					

Available Types

	Type	Power Supply	Control Feature	Output	Connection		5 m cable	4 pin, M8 plug	4 pin, M12 plug	Range
					Housing Material	Housing Type				
Transmitter	7000	10-30 V dc	Test Input	-	Polycarbonate	M18 x 1	SMT 7000 TP 5	SMT 7000 TP T4	SMT 7000 TP J	20 m
					Stainless Steel		SMT 7000 TS 5	SMT 7000 TS T4	SMT 7000 TS J	

Receiver	7607	10-30 V dc	Sensitivity pot. and light/dark switch	NPN/PNP	Polycarbonate	M18 x 1	SMR 7607 TP 5	SMR 7607 TP T4	SMR 7607 TP J	0-7 m
	Stainless Steel				SMR 7607 TS 5		SMR 7607 TS T4	SMR 7607 TS J		
	7620				Polycarbonate		SMR 7620 TP 5	SMR 7620 TP T4	SMR 7620 TP J	0-20 m
					Stainless Steel		SMR 7620 TS 5	SMR 7620 TS T4	SMR 7620 TS J	
	7707		Sensitivity pot.	PNP/PNP	Polycarbonate		SMR 7707 TP 5	SMR 7707 TP T4	SMR 7707 TP J	0-7 m
					Stainless Steel		SMR 7707 TS 5	SMR 7707 TS T4	SMR 7707 TS J	
	7720				Polycarbonate		SMR 7720 TP 5	SMR 7720 TP T4	SMR 7720 TP J	0-20 m
					Stainless Steel		SMR 7720 TS 5	SMR 7720 TS T4	SMR 7720 TS J	

Proximity	7600	10-30 V dc	Sensitivity pot. and light/dark switch	NPN/PNP	Polycarbonate	M18 x 1	SMP 7600 TP 5	SMP 7600 TP T4	SMP 7600 TP J	0-0,5 m
					Stainless Steel		SMP 7600 TS 5	SMP 7600 TS T4	SMP 7600 TS J	

Fibre Sensor	7600	10-30 V dc	Sensitivity pot. and light/dark switch	NPN/PNP	Polycarbonate	M18 x 1	SMPF 7600 TP 5	SMPF 7600 TP T4	SMPF 7600 TP J	Refer to page 154
					Stainless Steel		SMPF 7600 TS 5	SMPF 7600 TS T4	SMPF 7600 TS J	

Note: Glass fibre optic cable to be ordered separately.

Retro Reflective	7600	10-30 V dc	Sensitivity pot. and light/dark switch	NPN/PNP	Polycarbonate	M18 x 1	SMRR 7600 TP 5	SMRR 7600 TP T4	SMRR 7600 TP J	0-3 m
					Stainless Steel		SMRR 7600 TS 5	SMRR 7600 TS T4	SMRR 7600 TS J	

Note: Reflector to be ordered separately.

Connections

	Cable	M8 Plug / Cable	M12 Plug / Cable
Supply +	Brown	Pin 1 / Brown	Pin 1 / Brown
Supply -	Blue	Pin 3 / Blue	Pin 3 / Blue
SMT test input	Black	Pin 4 / Black	Pin 4 / Black
Output	Black	Pin 4 / Black	Pin 4 / Black
Output	White	Pin 2 / White	Pin 2 / White

4 pin, M8

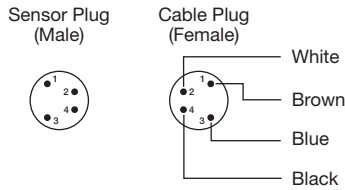

4 pin, M12

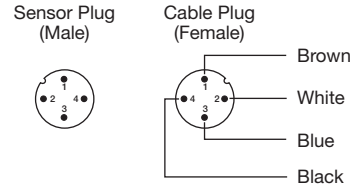

Refer to page 161 for extension cables

Wiring Diagrams

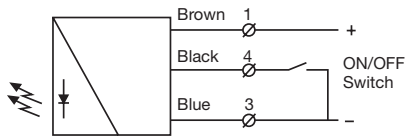

SMT 7000

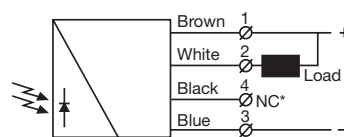

*Do not connect black wire
SMR 76xx (load as NPN)

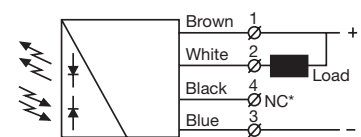

*Do not connect black wire
SMP / SMPF / SMRR 7600 (load as NPN)

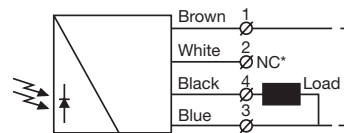

*Do not connect white wire
SMR 76xx (load as PNP)

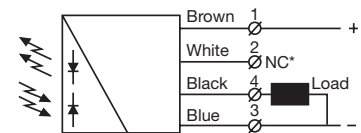

*Do not connect white wire
SMP / SMPF / SMRR 7600 (load as PNP)

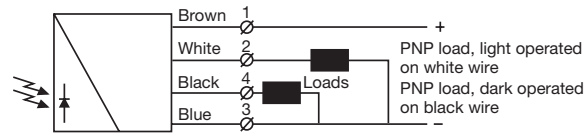

SMR 77xx

Dimensions and Descriptions

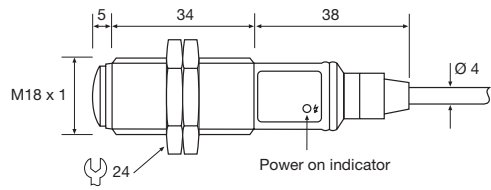

SMT 7000 TP/TS 5

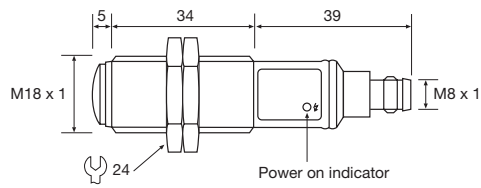

SMT 7000 TP/TS T4

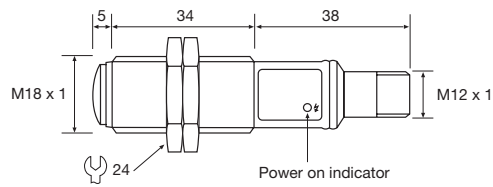

SMT 7000 TP/TS J

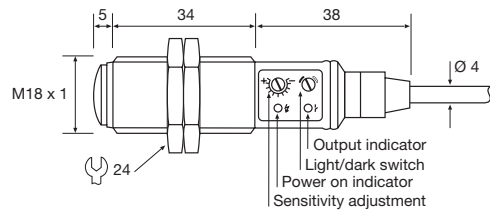

SMR / SMP / SMRR / SMPF* 76xx TP/TS 5

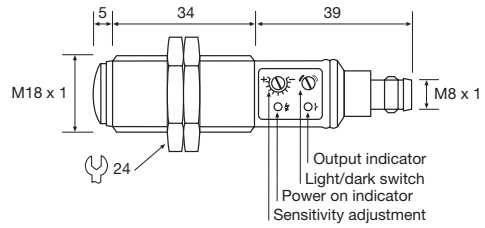

SMR / SMP / SMRR / SMPF* 76xx TP/TS T4

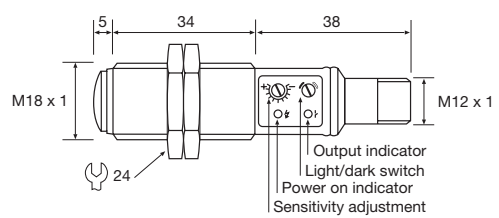

SMR / SMP / SMRR / SMPF* 76xx TP/TS J

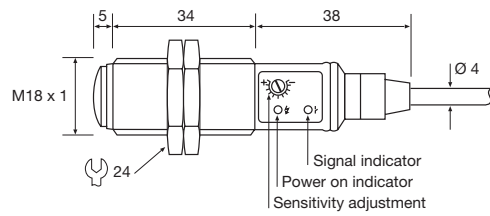

SMR 77xx TP/TS 5

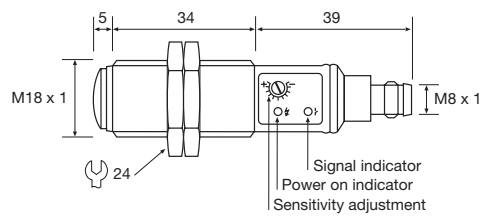

SMR 77xx TP/TS T4

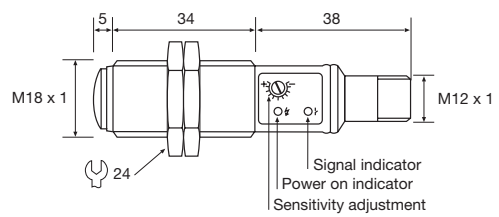

SMR 77xx TP/TS J

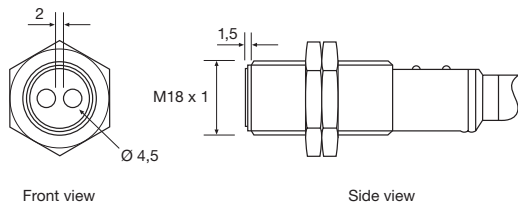

SMPF*

(Units in mm)

Sensing Characteristics

Parallel Displacement

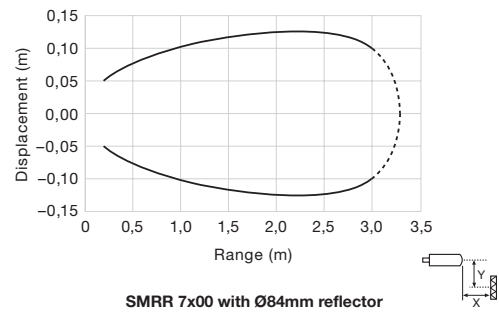
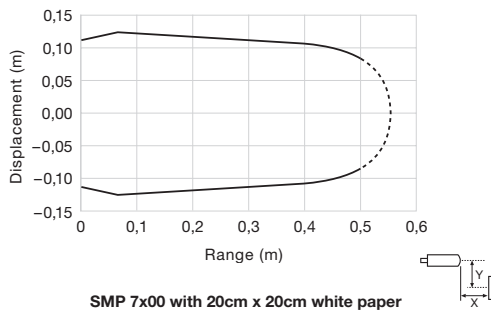
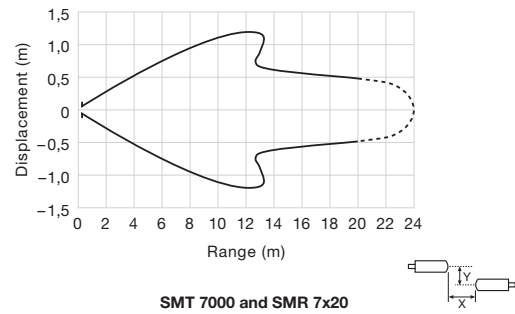
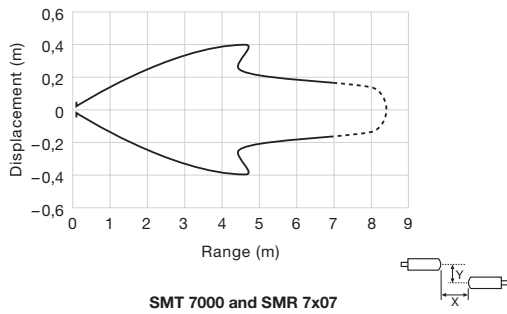

Angular Displacement

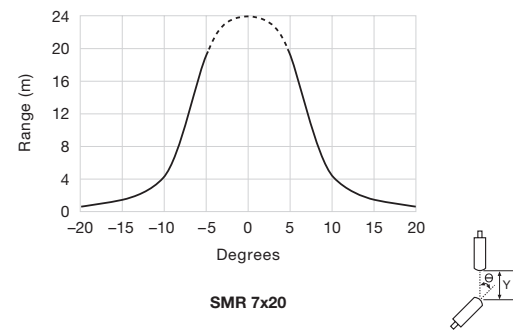
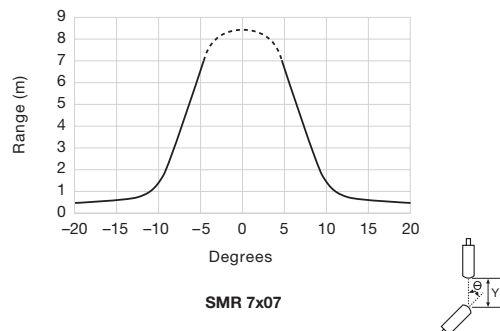
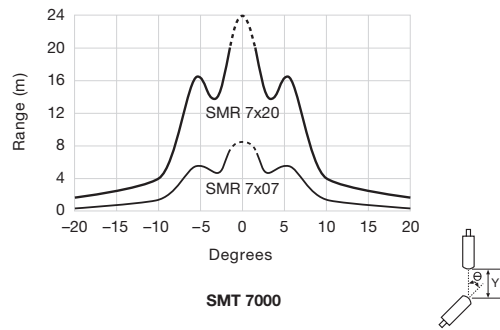

Telco reserves the right to change specifications without notice.

Description

- Operation mode and max sensing range:
Thru-beam: 0-20 m
Diffuse proximity: 0-0,5 m
Retro reflective: 0-3 m
Fibre: Dependent on fibre optic
- Cable or plug connection
- Sensitivity adjustment via potentiometer
- Switch selectable light or dark function
- Power and output indicators
- High tolerance to hostile environments
- 10-30 V dc or 20-250 V ac supply voltage
- 3 wire, NPN or PNP transistor output or 2 wire, SCR output
- Test input
- Available with optional  ATEX approval



The 8000 series consists of a self-contained transmitter SMT, and a receiver SMR which are to be used in thru-beam mode, an SMP for diffuse proximity, SMRR for retro reflective and an SMPF for use with fibre optic cables. All are offered with sensitivity adjustment via integral potentiometer with either cable or plug connection.

The complete series is available either as 3 wire, NPN or PNP transistor output with a 10-30 V dc supply voltage, or as 2 wire, SCR output with a

20-250 V ac supply voltage both offering switch selectable light or dark function. The control input in the 10-30 V dc SMT is intended to be used for disabling or enabling the transmitting power temporarily for test purpose or for multiplexing applications.

The dc series is protected against reverse polarity of power supplies, control input and output signals. The output is protected against short circuit and inductive loads.

		Technical Data				
		SMT	SMR		SMP	SMPF
			8x20	8x00		
Supply voltage	ac	20-250 V ac	-	20-250 V ac		
	dc	10-30 V dc				
Voltage ripple		15 %				
Reverse polarity protected	dc	Yes				
Short circuit protected	dc	-	Yes			
Current consumption	ac	3 mA	-	2 mA		
	dc	15 mA	5 mA		14 mA	
Maximum output load	ac	-	-	200 mA		
	dc	-	120 mA @ 30 V dc			
Maximum residual voltage	ac	-	-	8 V		
	dc	-	1,5 V			
Max. operation frequency	ac	-	-	20 Hz		
	dc	-	100 Hz	250 Hz		
Response time t _{ON} / t _{OFF}	ac	-	-	25 ms / 25 ms		
	dc	-	5 ms / 5 ms	2 ms / 2 ms		
Power on indicator		Green LED				
Output indicator		-	Yellow LED			
Hysteresis		-	Approx. 10-30 %		Approx. 5-15 %	
Light source		Infrared (880 nm)	-		Infrared (880 nm)	
Opening angle		-	+/- 6°		+/- 4°	+/- 3,5°
Emission angle		+/- 2°	-			
Housing material	Sensor housing	Stainless Steel (AISI 316 / 1.4401) or Polycarbonate				
	Front lens	Polycarbonate				
Cable, PVC	ac	Ø 5,2 mm, 2 x 0,25 mm ²				
	dc	Ø 4,0 mm, 3 x 0,14 mm ²				

Environmental Data						
	SMT	SMR		SMP	SMPF	SMRR
		8x20	8x00			
Vibration		10-55 Hz, 0,5 mm				
Shock		30 g				
Light immunity	@ 5° incidence	-	> 7 000 lux	> 10 000 lux	-	
	@ 15° incidence	-	-		> 40 000 lux	> 25 000 lux
Temperature, operation		-20 to +60 °C				
Temperature, storage		-40 to +80 °C				
Sealing class	ac	IP 60				
	dc	IP 67				
Approvals	ac	CE 				
	dc	CE				

Available Types										
Transmitter	Type	Power Supply	Control Feature	Output	Connection		5 m cable	3 pin, M8 plug	4 pin, M12 plug	Range
					Housing Material	Housing Type				
	8000	10-30 V dc	Test Input	-	-	Polycarbonate	M18 x 1	SMT 8000 PG 5	SMT 8000 PG T3	SMT 8000 PG J
Stainless Steel						SMT 8000 MG 5		SMT 8000 MG T3	SMT 8000 MG J	
20-250 V ac		-	Polycarbonate			SMT 8600 PG 5		-	-	7 m
			Stainless Steel			SMT 8600 MG 5		-	-	

Receiver	8400	10-30 V dc	Sensitivity pot. and light/dark switch	NPN	Polycarbonate	M18 x 1	SMR 8400 PG 5	SMR 8400 PG T3	SMR 8400 PG J	0-7 m		
					Stainless Steel		SMR 8400 MG 5	SMR 8400 MG T3	SMR 8400 MG J			
	8500			PNP	Polycarbonate		SMR 8500 PG 5	SMR 8500 PG T3	SMR 8500 PG J	0-20 m		
					Stainless Steel		SMR 8500 MG 5	SMR 8500 MG T3	SMR 8500 MG J			
	8420			NPN	Polycarbonate		SMR 8420 PG 5	SMR 8420 PG T3	SMR 8420 PG J			
					Stainless Steel		SMR 8420 MG 5	SMR 8420 MG T3	SMR 8420 MG J			
	8520			PNP	Polycarbonate		SMR 8520 PG 5	SMR 8520 PG T3	SMR 8520 PG J			
					Stainless Steel		SMR 8520 MG 5	SMR 8520 MG T3	SMR 8520 MG J			
	8800			20-250 V ac	Light/dark switch		SCR	Polycarbonate	SMR 8800 PG 5	-	-	7 m
								Stainless Steel	SMR 8800 MG 5	-	-	

Proximity	8400	10-30 V dc	Sensitivity pot. and light/dark switch	NPN	Polycarbonate	M18 x 1	SMP 8400 PG 5	SMP 8400 PG T3	SMP 8400 PG J	0-0,5 m	
					Stainless Steel		SMP 8400 MG 5	SMP 8400 MG T3	SMP 8400 MG J		
	8500			PNP	Polycarbonate		SMP 8500 PG 5	SMP 8500 PG T3	SMP 8500 PG J		
					Stainless Steel		SMP 8500 MG 5	SMP 8500 MG T3	SMP 8500 MG J		
	8800			20-250 V ac	SCR		Polycarbonate	SMP 8800 PG 5	-		-
							Stainless Steel	SMP 8800 MG 5	-		-

Fibre Sensor	8400	10-30 V dc	Sensitivity pot. and light/dark switch	NPN	Polycarbonate	M18 x 1	SMPF 8400 PG 5	SMPF 8400 PG T3	SMPF 8400 PG J	Refer to page 154	
					Stainless Steel		SMPF 8400 MG 5	SMPF 8400 MG T3	SMPF 8400 MG J		
	8500			PNP	Polycarbonate		SMPF 8500 PG 5	SMPF 8500 PG T3	SMPF 8500 PG J		
					Stainless Steel		SMPF 8500 MG 5	SMPF 8500 MG T3	SMPF 8500 MG J		
	8800			20-250 V ac	SCR		Polycarbonate	SMPF 8800 PG 5	-		-
							Stainless Steel	SMPF 8800 MG 5	-		-

Note: Glass fibre optic cable to be ordered separately.

Retro Reflective	8400	10-30 V dc	Sensitivity pot. and light/dark switch	NPN	Polycarbonate	M18 x 1	SMRR 8400 PG 5	SMRR 8400 PG T3	SMRR 8400 PG J	0-3 m	
					Stainless Steel		SMRR 8400 MG 5	SMRR 8400 MG T3	SMRR 8400 MG J		
	8500			PNP	Polycarbonate		SMRR 8500 PG 5	SMRR 8500 PG T3	SMRR 8500 PG J		
					Stainless Steel		SMRR 8500 MG 5	SMRR 8500 MG T3	SMRR 8500 MG J		
	8800			20-250 V ac	SCR		Polycarbonate	SMRR 8800 PG 5	-		-
							Stainless Steel	SMRR 8800 MG 5	-		-

Note: Reflector to be ordered separately.

SM 8000 series with cable connection is available to comply with ATEX  II 3 GD T6 EEx nA II U. Add "/EX" after the series number e.g. SMT 8000/EX PG 5.

Connections

	Cable	M8 Plug / Cable	M12 Plug / Cable
AC supply	Blue & Brown	-	-
Supply +	Brown	Pin 1 / Brown	Pin 1 / Brown
Supply -	Blue	Pin 3 / Blue	Pin 3 / Blue
SMT test input	Black	Pin 4 / Black	Pin 4 / Black
Output	Black	Pin 4 / Black	Pin 4 / Black

3 pin, M8

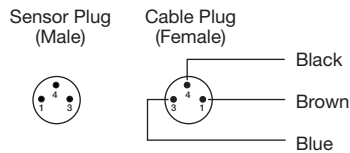

4 pin, M12

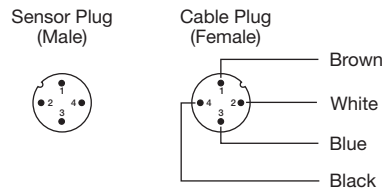

Refer to page 161 for extension cables

Wiring Diagrams

AC Models

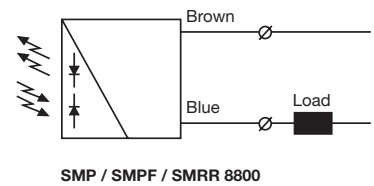
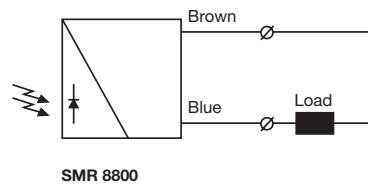
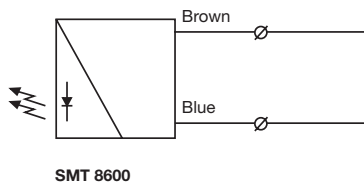

DC Models

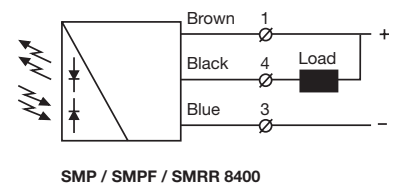
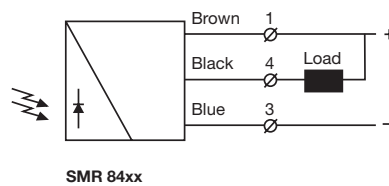
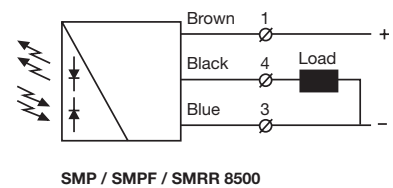
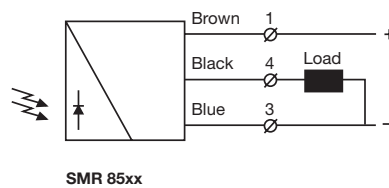
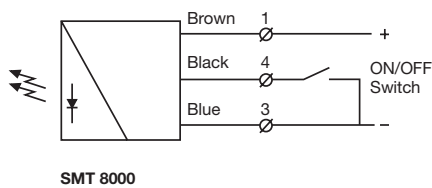

Dimensions and Descriptions

AC Models

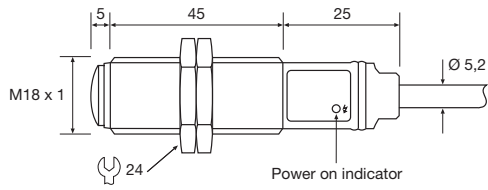

SMT PG/MG 5

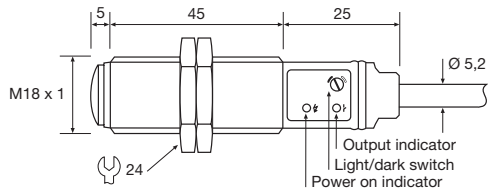

SMR PG/MG 5

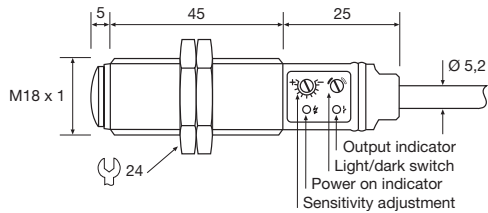

SMP / SMRR / SMPF* PG/MG 5

DC Models

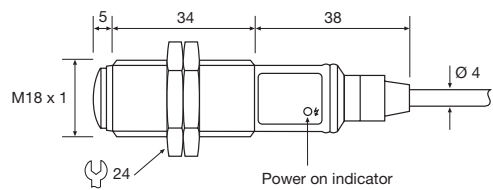

SMT PG/MG 5

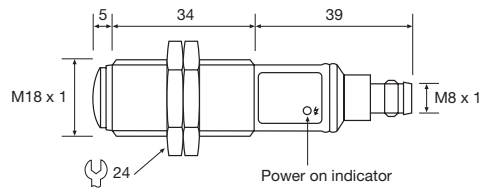

SMT PG/MG T3

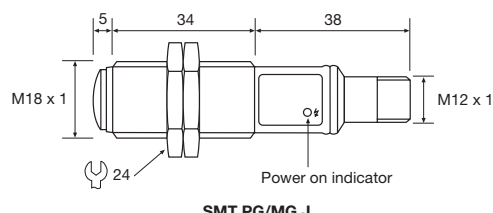

SMT PG/MG J

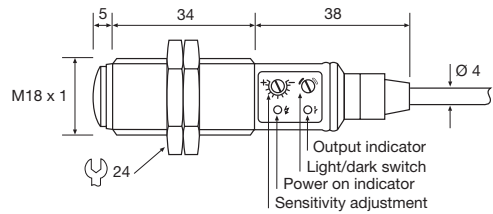

SMR / SMP / SMRR / SMPF* PG/MG 5

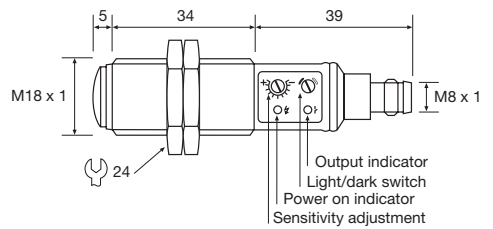

SMR / SMP / SMRR / SMPF* PG/MG T3

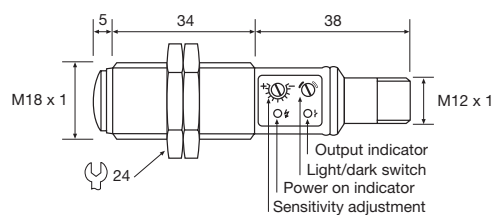

SMR / SMP / SMRR / SMPF* PG/MG J

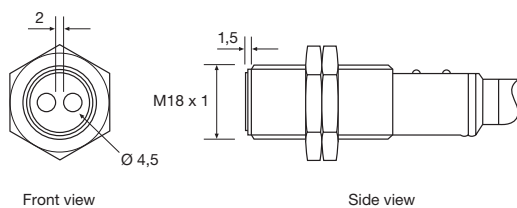

SMPF*

(Units in mm)

Sensing Characteristics

Parallel Displacement

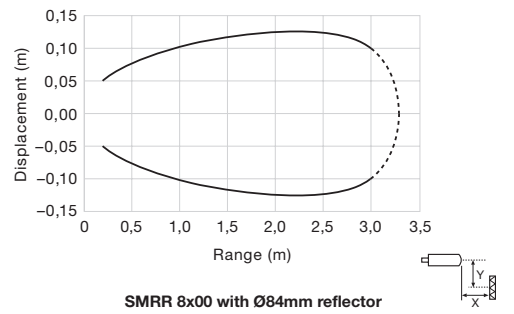
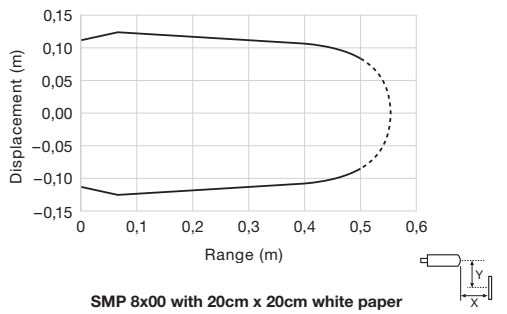
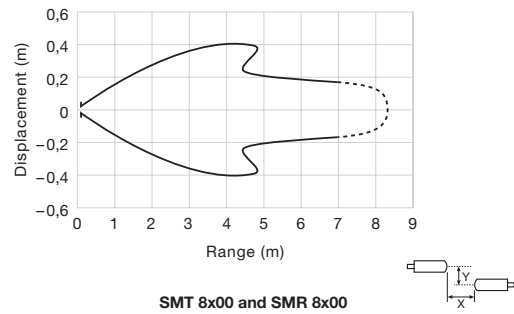
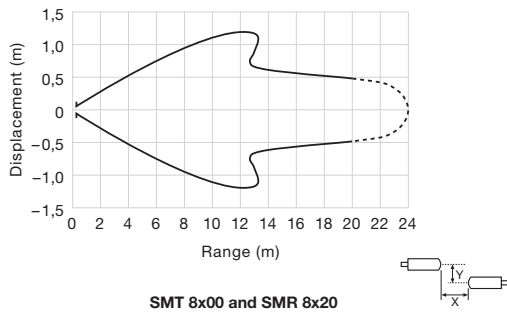

Angular Displacement

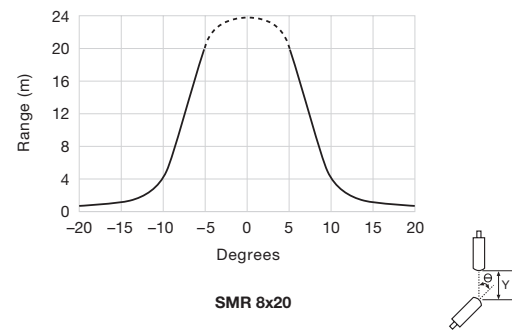
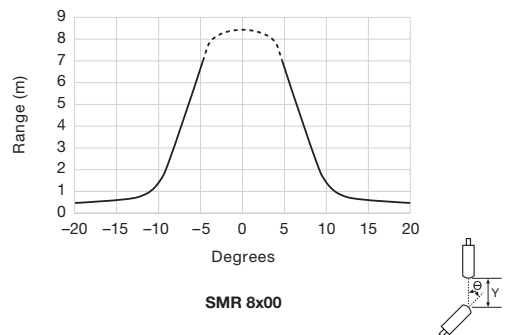
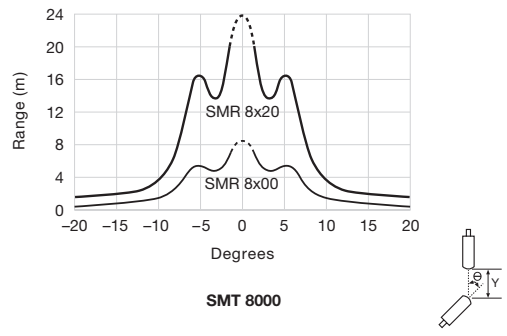

Telco reserves the right to change specifications without notice.

Description

- Operation mode and max sensing range:
Thru-beam: 1-70 m
- Cable or plug connection
- Sensitivity adjustment via control input
- Power and output indicators
- High tolerance to hostile environments
- 10-30 V dc supply voltage
- 5 wire, NPN or PNP output
- Test input
- High excess gain
- Optical cross talk elimination of 4 independent sensor channels selectable via wire connection



The SM 9000 series consists of a high-power self-contained transmitter SMT, and receiver SMR, which are to be used in thru-beam mode. The complete series is available in stainless steel or plastic housing with either cable or plug connection.

The complete series is available with a 10-30 V dc supply voltage with a 5 wire, NPN or PNP transistor output with a choice between light or dark function. The control input in the SMT may be used for either disabling or enabling the transmitting power temporarily for test purpose, multiplexing applications or as gradual regulation of the transmitting power level.

The SM 9000 series features cross talk elimination which enables up to 4 individual sensor pairs to operate independently, configurable with the use of a 2-wire channel selection in the SMT and SMR, ensuring that optical cross talk interference between the channels is prevented.

Both the transmitter and receiver are protected against reverse polarity of power supplies, control input and output signals. The output is also protected against short circuit and inductive loads.

Technical Data					
		SMT		SMR	
		9020C	9070C	9x20	9x70
Supply voltage		10-30 V dc			
Voltage ripple		15 %			
Reverse polarity protected		Yes			
Short circuit protected		-		Yes	
Current consumption		Max. 40 mA			
Maximum output load		-		100 mA	
Maximum residual voltage		-		2,5 V	
Maximum operation frequency		-		20 Hz	
Response time t _{ON} / t _{OFF}		-		25 ms / 25 ms	
Power on indicator		Green LED		-	
Output indicator		-		Yellow LED	
Hysteresis		-		Approx. 20 %	
Transmitter diode		Ga Al As (880 nm)		-	
Opening angle		-		+/- 7°	+/- 3°
Emission angle		+/- 7°	+/- 4°	-	
Housing material	Sensor housing	Stainless Steel (AISI 316 / 1.4401) or Polycarbonate			
	Front lens	Polycarbonate			
Cable, PVC Ø 4,9 mm		5 x 0,14 mm ²			

Environmental Data

	SMT	SMR	
		9x20	9x70
Vibration	10-55 Hz, 0,5 mm		
Shock	30 g		
Light immunity, @ 5° incidence	-	> 10 000 lux	> 20 000 lux
Temperature, operation	-20 to +60 °C		
Temperature, storage	-40 to +80 °C		
Sealing class	IP 69K		
Approvals	CE		

Note: Sensors are IP 69K rated if the cable is protected from high-pressure spray.

Available Types

	Type	Control Feature	Output	Connection		5 m cable	15 m cable	0,1 m cable with 5 pin, M12 plug	Range
				Housing Material	Housing Type				
Transmitter	9020C	Adjustable range and test input	-	Polycarbonate	M18 x 1	SMT 9020C TP 5	SMT 9020C TP 15	SMT 9020C TP 0.1-J5	1-20 m
				Stainless Steel		SMT 9020C TS 5	SMT 9020C TS 15	SMT 9020C TS 0.1-J5	
Receiver	9020	-	NPN LO (NC)	Polycarbonate	M18 x 1	SMR 9020 TP 5	SMR 9020 TP 15	SMR 9020 TP 0.1-J5	20 m
				Stainless Steel		SMR 9020 TS 5	SMR 9020 TS 15	SMR 9020 TS 0.1-J5	
	9120		NPN DO (NO)	Polycarbonate		SMR 9120 TP 5	SMR 9120 TP 15	SMR 9120 TP 0.1-J5	
				Stainless Steel		SMR 9120 TS 5	SMR 9120 TS 15	SMR 9120 TS 0.1-J5	
	9220		PNP LO (NC)	Polycarbonate		SMR 9220 TP 5	SMR 9220 TP 15	SMR 9220 TP 0.1-J5	
				Stainless Steel		SMR 9220 TS 5	SMR 9220 TS 15	SMR 9220 TS 0.1-J5	
	9320		PNP DO (NO)	Polycarbonate		SMR 9320 TP 5	SMR 9320 TP 15	SMR 9320 TP 0.1-J5	
				Stainless Steel		SMR 9320 TS 5	SMR 9320 TS 15	SMR 9320 TS 0.1-J5	
Transmitter	9070C	Adjustable range and test input	-	Polycarbonate	M18 x 1	SMT 9070C TP 5	SMT 9070C TP 15	SMT 9070C TP 0.1-J5	1-70 m
				Stainless Steel		SMT 9070C TS 5	SMT 9070C TS 15	SMT 9070C TS 0.1-J5	
Receiver	9070	-	NPN LO (NC)	Polycarbonate	M18 x 1	SMR 9070 TP 5	SMR 9070 TP 15	SMR 9070 TP 0.1-J5	70 m
				Stainless Steel		SMR 9070 TS 5	SMR 9070 TS 15	SMR 9070 TS 0.1-J5	
	9170		NPN DO (NO)	Polycarbonate		SMR 9170 TP 5	SMR 9170 TP 15	SMR 9170 TP 0.1-J5	
				Stainless Steel		SMR 9170 TS 5	SMR 9170 TS 15	SMR 9170 TS 0.1-J5	
	9270		PNP LO (NC)	Polycarbonate		SMR 9270 TP 5	SMR 9270 TP 15	SMR 9270 TP 0.1-J5	
				Stainless Steel		SMR 9270 TS 5	SMR 9270 TS 15	SMR 9270 TS 0.1-J5	
	9370		PNP DO (NO)	Polycarbonate		SMR 9370 TP 5	SMR 9370 TP 15	SMR 9370 TP 0.1-J5	
				Stainless Steel		SMR 9370 TS 5	SMR 9370 TS 15	SMR 9370 TS 0.1-J5	

Connections

	Cable	M12 Plug / Cable
Supply +	Brown	Pin 1 / Brown
Supply -	Blue	Pin 3 / Blue
SMT control input	Black	Pin 4 / Black
SMR output	Black	Pin 4 / Black
SMT/SMR channel selection	Grey	Pin 5 / Grey
SMT/SMR channel selection	White	Pin 2 / White

5 pin, M12

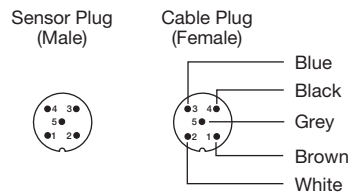

Refer to page 161 for extension cables

Wiring Diagrams

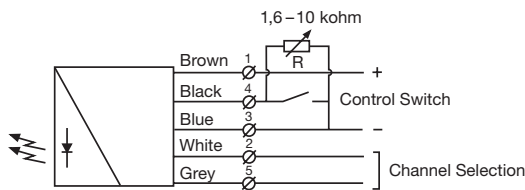

SMT 90xxC
Variable range and ON/OFF switch for transmitting power

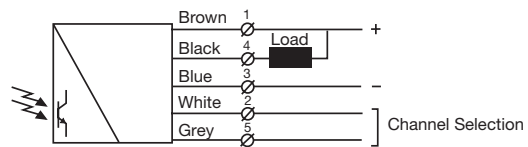

SMR 90xx / 91xx

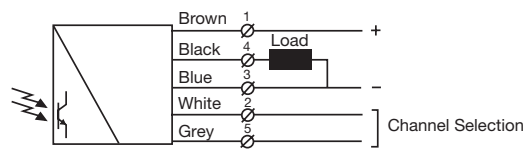

SMR 92xx / 93xx

Channel Selection

SMT / SMR

Channel Number	Connection Configuration	
	Grey wire	White wire
1	Supply - (blue wire)	Supply - (blue wire)
2	Supply + (brown wire)	Supply - (blue wire)
3	Supply - (blue wire)	Supply + (brown wire)
4	Supply + (brown wire)	Supply + (brown wire)

Dimensions and Descriptions

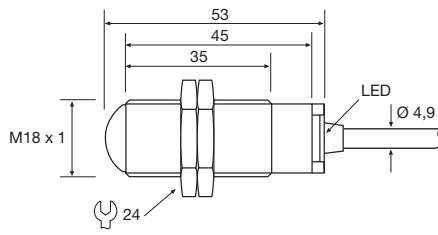

TP/TS 5/15/0.1-J5

(Units in mm)

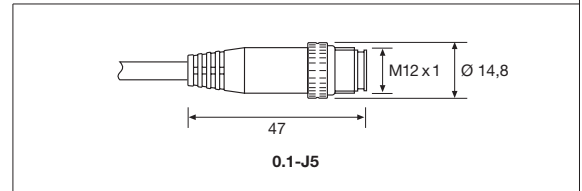

0.1-J5

Sensing Characteristics

Parallel Displacement

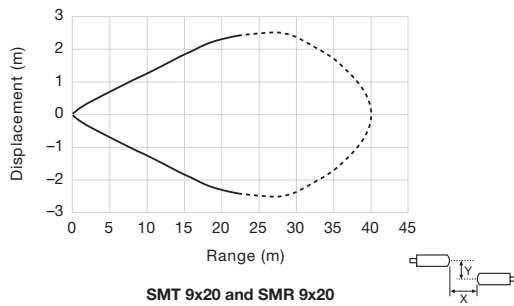

SMT 9x20 and SMR 9x20

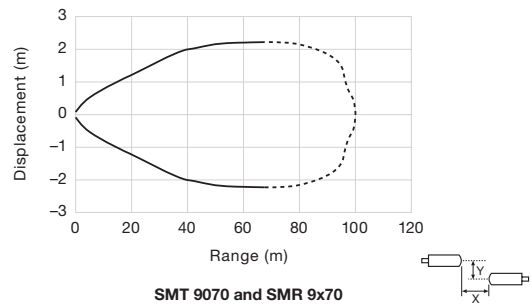

SMT 9070 and SMR 9x70

Angular Displacement

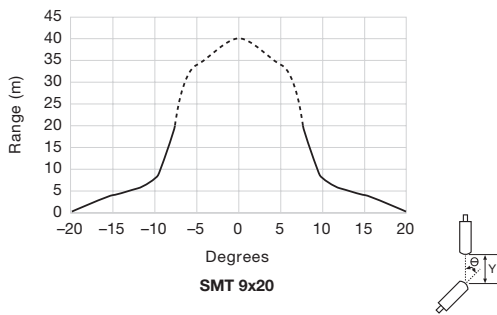

SMT 9x20

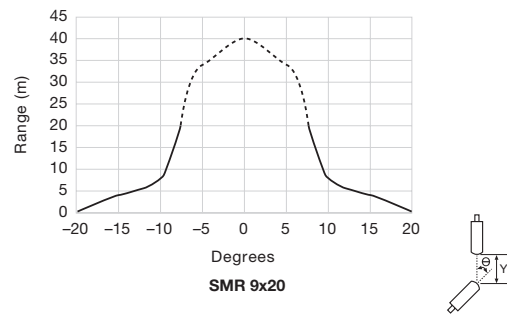

SMR 9x20

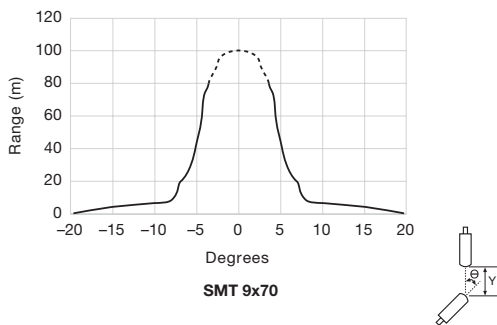

SMT 9x70

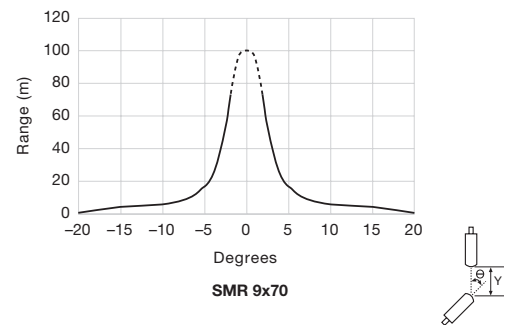

SMR 9x70



SPACEPAK SERIES

Some might say that the SpacePak series looks like many other sensors – and they are right. But that is as far as it goes. Having applied our many years of experience in photoelectric sensors, together with the latest technology, has ensured that this series is incomparable in terms of performance and precision – the difference comes from within.



Description

- Operation mode and max sensing range:
 - Thru-beam: 0-45 m
 - Retro reflective: 0,1-12 m
 - Polarised retro reflective: 0,1-10 m
 - Diffuse proximity: 0-3 m
 - Background suppression: 0-1,5 m
- Compact rectangular housing (50x50 mm)
- Cable or rotatable plug connection
- Sensitivity adjustment via potentiometer
- Switch selectable light or dark function
- Adjustable on/off time delay
- Power, output and signal level indicators
- 10-30 V dc or 12-240 V ac/dc supply voltage
- 4 wire, NPN/PNP output or 5 wire relay output
- Test input

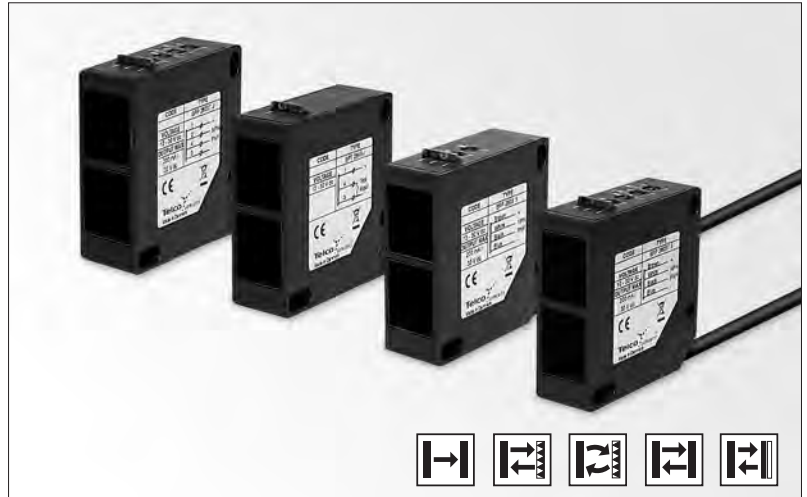

The SP 2000 series consists of a self-contained transmitter SPT and receiver SPR, which are to be used in thru-beam mode, SPRR for retro-reflective, SPPR for polarised retro-reflective, an SPP for diffuse proximity and SPBS for background suppression. All are offered with sensitivity adjustment via integral potentiometer with either cable or 180° rotatable plug connection.

The complete series is available either as a 4 wire, NPN/PNP transistor output with 10-30 V dc supply voltage or as a 5 wire, relay output with a 12-240 V ac/dc supply voltage both offering switch selectable light or dark function and potentiometer adjustable 0-10 sec on/off time delay.

The test input in the 10-30 V dc, SPT is intended to be used for disabling or enabling the transmitter power temporarily for test purposes or for multiplexing applications.

The dc series is protected against reverse polarity of power supplies, test input and output signals. The output is protected against short circuit and inductive loads.

Technical Data

		SPT	SPR	SPRR	SPPR	SPP	SPBS
Supply voltage	ac / dc	12-240 V dc / 20-240 V ac					
	dc	10-30 V dc					
Voltage ripple		+/- 15 %					
Output	Relay	-	1 open / 1 close, 240 V ac / 2 A				
	Transistor	-	200 mA / 30 V dc				
Reverse polarity protected	dc	Yes					
Short circuit protected	dc	-	Yes				
Current consumption	ac	< 70 mA					
	dc	< 65 mA					
Maximum operation frequency	ac	-	25 Hz				
	dc	-	250 Hz				
Response time t_{ON} / t_{OFF}	ac	-	20 ms / 20 ms				
	dc	-	2 ms / 2 ms				
Delay t_{ON} / t_{OFF}		-	0-10 sec, adjustable				
Power on indicator		Green LED					
Output indicator		-	Yellow LED				
Signal status indicator		-	Red LED				
Hysteresis		-	20-30 %	Approx. 10 %		5-15 %	3-10 %
Light source		Infrared (880 nm)	-	Infrared (880 nm)	Visible Red (670 nm)	Infrared (880 nm)	
Opening angle		-	+/- 2,5°	+/- 1,5°		+/- 5°	
Emission angle		+/- 2°	-	+/- 2°		+/- 1,5°	
Housing material	Sensor housing	Polycarbonate / ABS					
	Front lens	Polycarbonate					
Cable, PVC Ø 4,9 mm	ac	2 x 0,20 mm ²	5 x 0,20 mm ²				
	dc	3 x 0,20 mm ²	4 x 0,20 mm ²				

Environmental Data

		SPT	SPR	SPRR	SPPR	SPP	SPBS
Vibration		10-55 Hz, 0.5 mm					
Shock		30 g					
Light immunity	@ 5° incidence	-	25 000 lux	25 000 lux		-	
	@ 15° incidence	-	-	-		25 000 lux	
Temperature, operation		-20 to +55 °C					
Temperature, storage		-40 to +80 °C					
Sealing class		IP 67					
Approvals	ac	CE 					
	dc	CE					

Available Types

Transmitter	Type	Power Supply	Control Feature	Time Delay	Connection	5 m cable	4 pin, M12 plug	Range
					Output	Order Reference		
2645	2645	10-30 V dc	Test Input	-	-	SPT 2645 5	SPT 2645 J	45 m

Receiver	2645	10-30 V dc	Sensitivity potentiometer and light/dark switch	On/Off Delay	NPN/PNP	SPR 2645T 5	SPR 2645T J	0-45 m
				-		SPR 2645 5	SPR 2645 J	
	2945	12-240 V ac / dc		On/Off Delay	Relay	SPR 2945T 5	-	
	-	SPR 2945 5		-				

Retro-Reflective	2612	10-30 V dc	Sensitivity potentiometer and light/dark switch	On/Off Delay	NPN/PNP	SPRR 2612T 5	SPRR 2612T J	0,1-12 m
				-		SPRR 2612 5	SPRR 2612 J	
	2912	12-240 V ac / dc		On/Off Delay	Relay	SPRR 2912T 5	-	
	-	SPRR 2912 5		-				

Note: Reflector to be ordered separately.

Polarised Retro-Reflective	2610	10-30 V dc	Sensitivity potentiometer and light/dark switch	On/Off Delay	NPN/PNP	SPPR 2610T 5	SPPR 2610T J	0,1-10 m
				-		SPPR 2610 5	SPPR 2610 J	
	2910	12-240 V ac / dc		On/Off Delay	Relay	SPPR 2910T 5	-	
	-	SPPR 2910 5		-				

Note: Reflector to be ordered separately.

Diffuse Proximity	2603	10-30 V dc	Sensitivity potentiometer and light/dark switch	On/Off Delay	NPN/PNP	SPP 2603T 5	SPP 2603T J	0-3 m
				-		SPP 2603 5	SPP 2603 J	
	2903	12-240 V ac / dc		On/Off Delay	Relay	SPP 2903T 5	-	
	-	SPP 2903 5		-				

Background Suppression	2600	10-30 V dc	Range potentiometer and light/dark switch	On/Off Delay	NPN/PNP	SPBS 2600T 5	SPBS 2600T J	0-0,5 m
				-		SPBS 2600 5	SPBS 2600 J	
	2900	12-240 V ac / dc		On/Off Delay	Relay	SPBS 2900T 5	-	
				-	SPBS 2900 5	-		
	2601	10-30 V dc		On/Off Delay	NPN/PNP	SPBS 2601T 5	SPBS 2601T J	0-1,5 m
				-		SPBS 2601 5	SPBS 2601 J	
	2901	12-240 V ac / dc		On/Off Delay	Relay	SPBS 2901T 5	-	
				-	SPBS 2901 5	-		

Connections		
	Cable	M12 Plug / Cable
AC/DC		
Supply + / ~	Brown	-
Supply - / ~	Blue	-
Output NC	Grey	-
Output NO	Black	-
Output C	White	-
DC		
Supply +	Brown	Pin 1 / Brown
Supply -	Blue	Pin 3 / Blue
SPT test input	Black	Pin 4 / Black
Output NPN	White	Pin 2 / White
Output PNP	Black	Pin 4 / Black

4 pin, M12

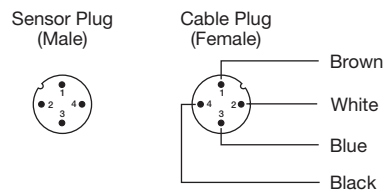

Refer to page 161 for extension cables

Wiring Diagrams

AC/DC Models

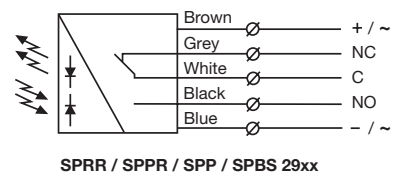
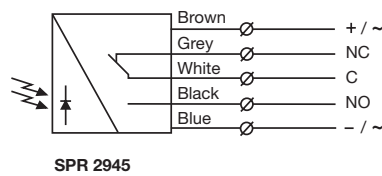
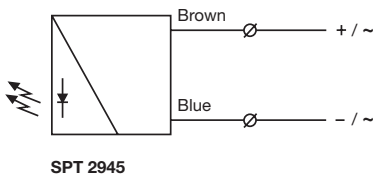

DC Models

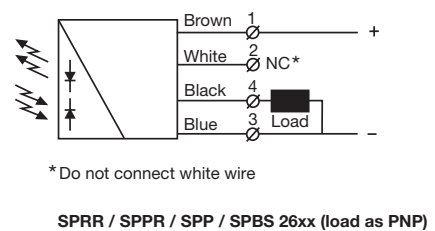
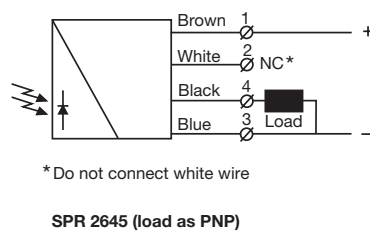
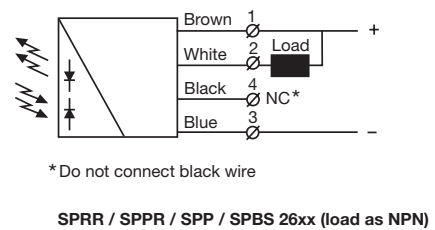
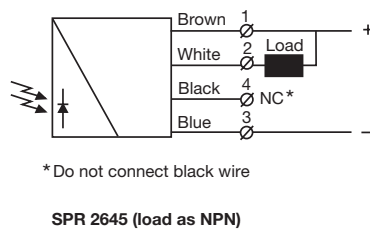
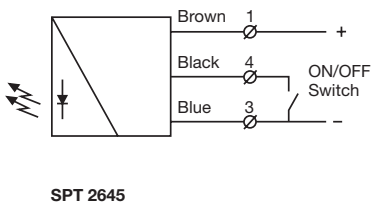

Dimensions and Descriptions

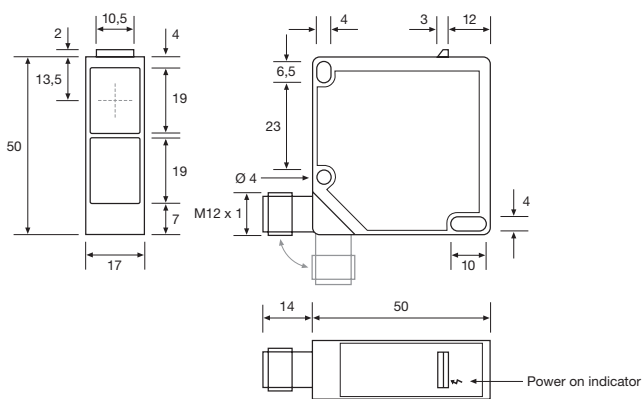

SPT 2645 J

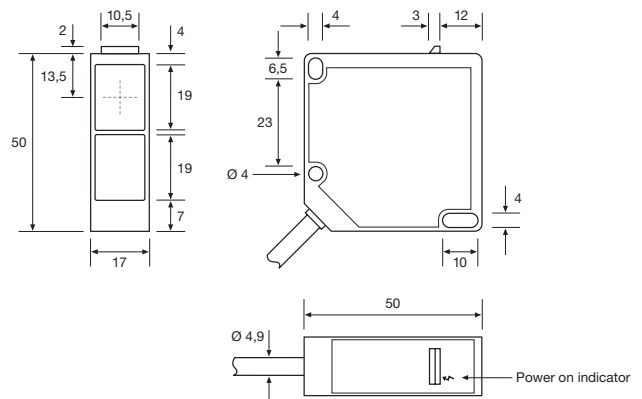

SPT 2x45 5

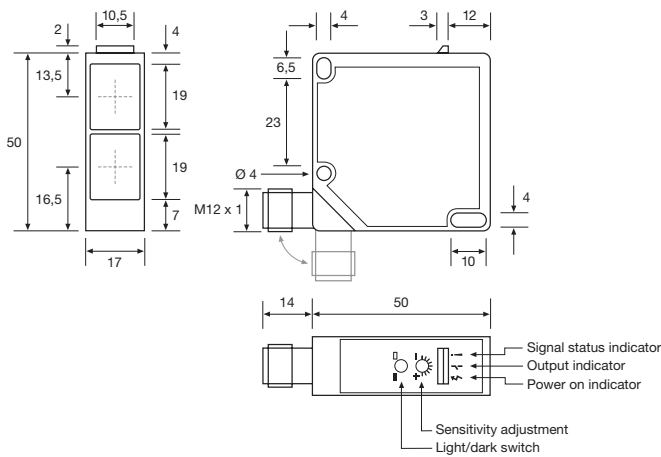

SPR / SPRR / SPPR / SPP / SPBS 26xx J

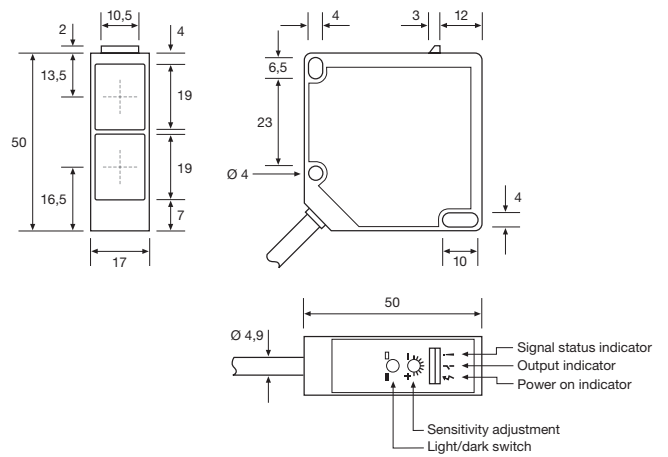

SPR / SPRR / SPPR / SPP / SPBS 2xxx 5

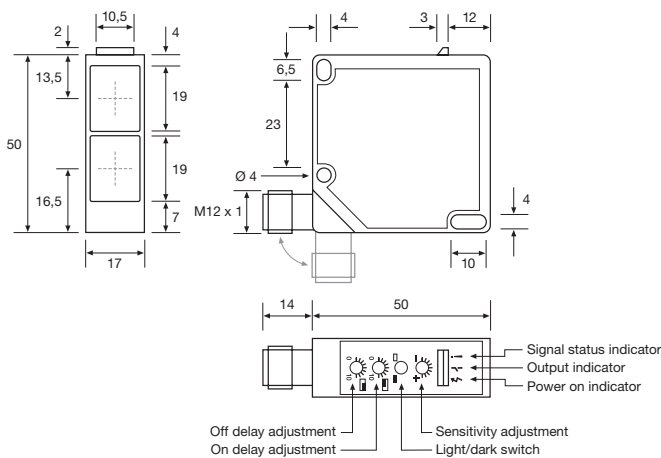

SPR / SPRR / SPPR / SPP / SPBS 26xxT J

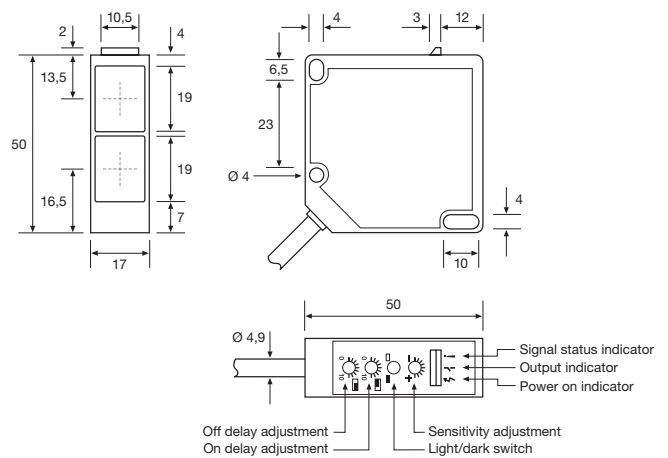

SPR / SPRR / SPPR / SPP / SPBS 2xxxT 5

(Units in mm)

Dimensions and Descriptions

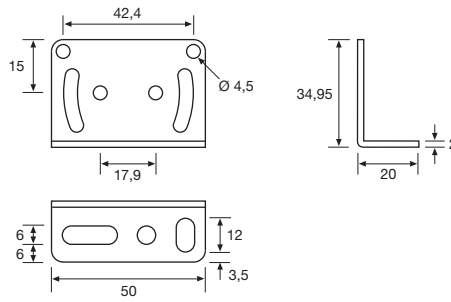

TR SP35-50 L
Stainless steel AISI 304
(Included with each unit)

(Units in mm)

Sensing Characteristics

Parallel Displacement

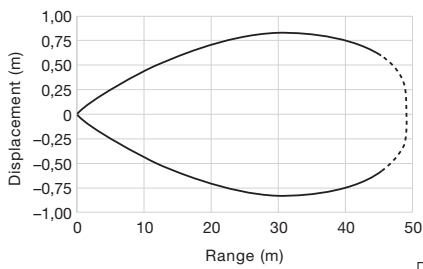

SPT 2x45 and SPR 2x45

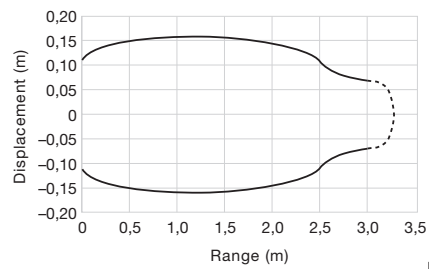
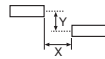

SPP 2x03

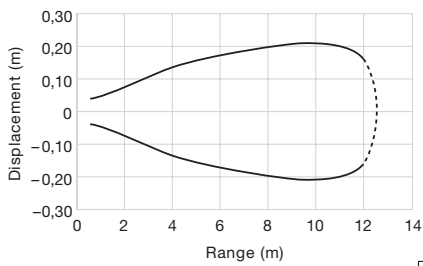

SPRR 2x12

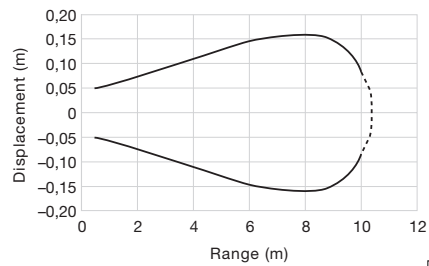

SPPR 2x10

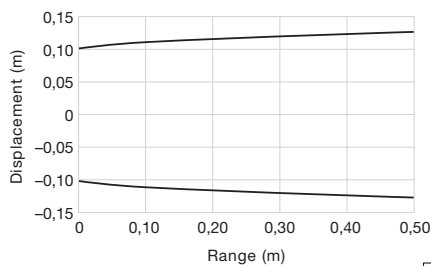

SPBS 2x00

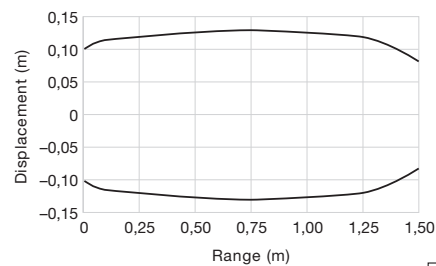

SPBS 2x01



Telco reserves the right to change specifications without notice.

Sensing Characteristics

Angular Displacement

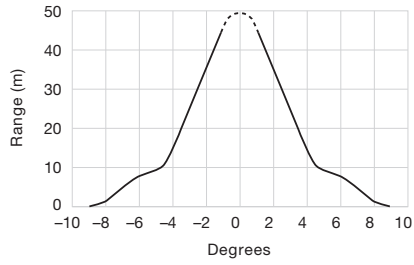

SPT

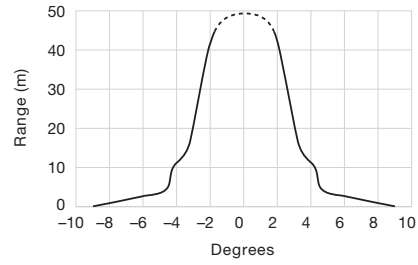

SPR



Telco reserves the right to change specifications without notice.



SPACEGUARD SERIES

The SpaceGuard series has never been anything less than impressive. The slim, but durable, design of our detectors has never failed to raise eyebrows. Yet this signature design has never hindered nor compromised its technology or performance in any way – on the contrary, it has inspired creative and innovative engineering in every way.

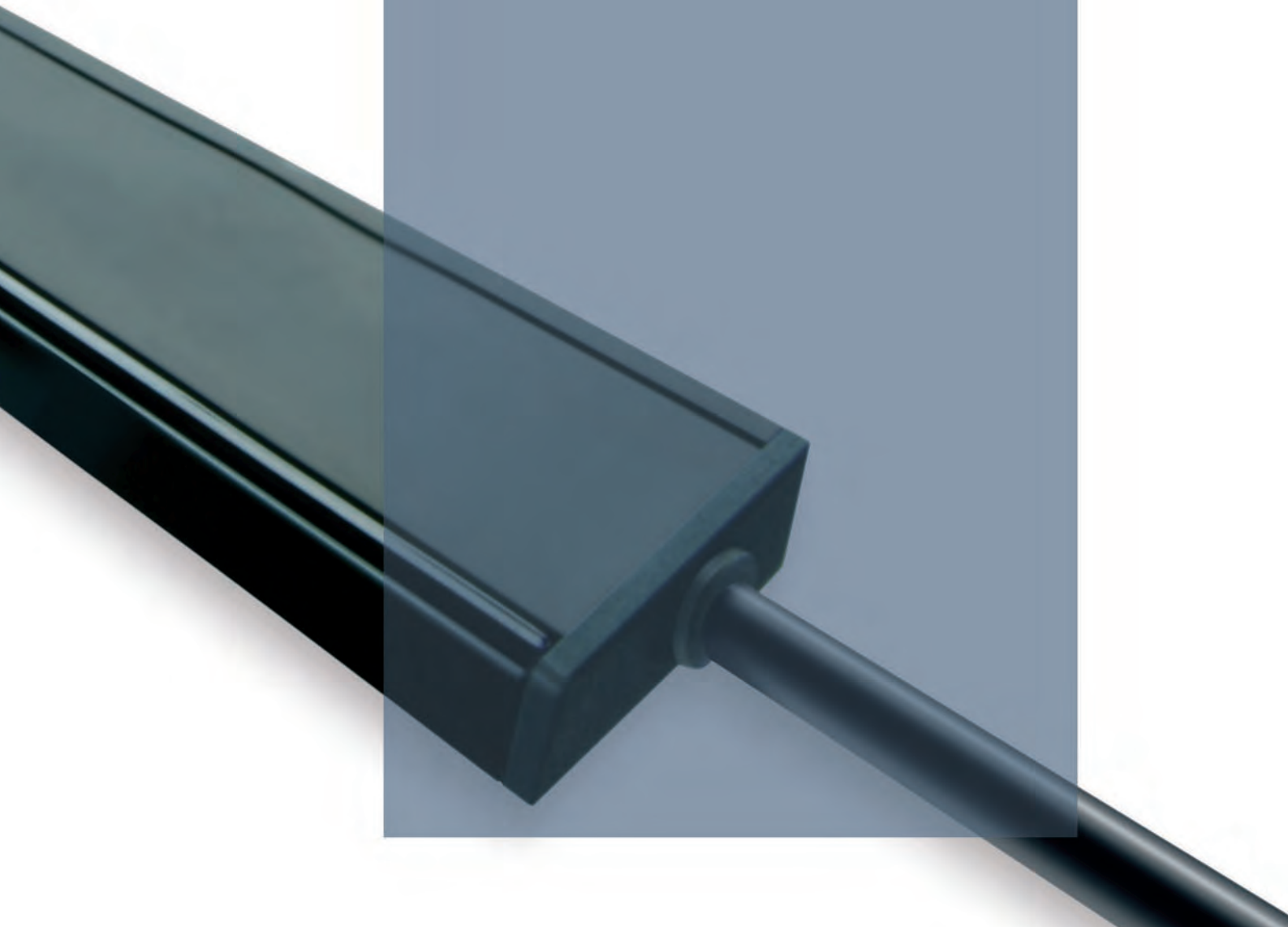

Description

- 0-4 m sensing range
- 34 to 194 cross scanning beams
- Active height of 650 mm to 1800 mm
- Detector length 850 mm to 2100 mm
- Flexible cable connection
- Automatic sensitivity adjustment
- Slim line (10x28 mm), leading edge (37,5x13 mm) or water-resistant slim line (12x30 mm) detector housing
- Power, output and signal status indicators
- 12-36 V dc supply voltage
- 5 wire, solid state relay output
- Test input
- Time-out function via wire connection
- Static and dynamic applications



The SG 1 light curtain system consists of a self-contained transmitter detector, SGT and receiver detector, SGR, which are to be positioned opposite of each other. The detectors are housed in a sturdy aluminium profile available in a slim line design (10 x 28 mm), a leading edge design (37,5 x 13 mm) and a water-resistant slim line design (12 x 30 mm).

The SGR is supplied with a 12-36 V dc power supply with a 5 wire, solid state relay output, with a choice of light or dark function. The test input in the SGT may be used for either disabling or enabling the transmitting power temporarily for test purposes.

The detectors also include time-out function, which allows a pre-set number of non-adjacent channels to be automatically ignored if

permanently obstructed for 10 seconds or more. This function can be enabled or disabled via the connection wire.

The advanced automatic signal-tracking (AST) feature ensures that no onsite set up or adjustments are required. The signal level of each individual channel is adjusted automatically compensating for misalignment and contamination during operation. Transmitter and receiver detectors are optically synchronised. The system can be used both in static and dynamic installations.

Both the transmitter and receiver detectors are protected against reverse polarity of power supplies, control input and output signals. The output is also protected against short circuit and inductive loads.

Technical Data

	46 mm channel spacing		92 mm channel spacing	
	SGT	SGR	SGT	SGR
Supply voltage	12-36 V dc			
Current consumption	Max. 100 mA	50 mA	Max. 100 mA	50 mA
Output rating	Solid state			
	-	200 mA	-	200 mA
Short circuit protected	-	Yes	-	Yes
Reverse polarity protected	Yes			
Light source	Infrared (940 nm)	-	Infrared (940 nm)	-
Number of channels (diodes per detector)	16, 24, 32 or 40		8, 12, 16 or 20	
Number of cross scanning beams	74, 114, 154 or 194		34, 54, 74 or 94	
Active height	695, 1065, 1430 or 1800 mm		650, 1020, 1385 or 1755 mm	
Channel spacing	46 mm		92 mm	
Bottom spacing to Ch 1	25 mm			
Pinch point beam spacing	23 mm		46 mm	
Response time	-	< 80 ms	-	< 40 ms
Power on indicator	Green LED			
Output indicator	-	Yellow LED	-	Yellow LED
System status indicator	-	Red LED	-	Red LED
Time-out function	Up to 4 non-adjacent channels, selectable		Up to 2 non-adjacent channels, selectable	
Housing dimensions (w x d)	Slim Line A	10 x 28 mm		
	Leading Edge B	37,5 x 13 mm		
	Slim Line C	12 x 30 mm		
Housing material	Profile	Aluminium (black anodised)		
	Lens cover	Polycarbonate		
Connection	3 m fixed flexible cable			
Cable, PVC Ø 4,1 mm	3 x 0,14 mm ²	5 x 0,14 mm ²	3 x 0,14 mm ²	5 x 0,14 mm ²

Environmental Data

		SGT	SGR
Light immunity @ 5° incidence		-	> 100 000 lux
Temperature, operation		-20 to +65 °C	
Temperature, storage		-40 to +80 °C	
Sealing class	A / B housing	IP 54	
	C housing	IP 67	
Approvals		CE	

Available Types

Slim Line A

	Housing Length	Active Height	Number of Channels	Number of Beams	Beam Spacing	Connection		3 m flexible cable	Range
						Output	Order Reference		
Transmitter Detector	850 mm	650 mm	8	34	92 mm	-	-	SGT 1-085-008-B1-A-00-3F	4 m
		695 mm	16	74	46 mm			SGT 1-085-016-A1-A-00-3F	
	1250 mm	1020 mm	12	54	92 mm			SGT 1-125-012-B1-A-00-3F	
		1065 mm	24	114	46 mm			SGT 1-125-024-A1-A-00-3F	
	1600 mm	1385 mm	16	74	92 mm			SGT 1-160-016-B1-A-00-3F	
		1430 mm	32	154	46 mm			SGT 1-160-032-A1-A-00-3F	
	2000 mm	1755 mm	20	94	92 mm			SGT 1-200-020-B1-A-00-3F	
		1800 mm	40	194	46 mm			SGT 1-200-040-A1-A-00-3F	
	2100 mm	1755 mm	20	94	92 mm			SGT 1-210-020-B1-A-00-3F	
		1800 mm	40	194	46 mm			SGT 1-210-040-A1-A-00-3F	

	Housing Length	Active Height	Number of Channels	Number of Beams	Beam Spacing	Solid State Relay	Connection		Range
							Output	Order Reference	
Receiver Detector	850 mm	650 mm	8	34	92 mm	Solid State Relay	DO (NO)	SGR 1-085-008-B1-A-04-3F	0-4 m
		695 mm	16	74	46 mm		LO (NC)	SGR 1-085-008-B1-A-05-3F	
	1250 mm	1020 mm	12	54	92 mm		DO (NO)	SGR 1-085-016-A1-A-04-3F	
		1065 mm	24	114	46 mm		LO (NC)	SGR 1-085-016-A1-A-05-3F	
	1600 mm	1385 mm	16	74	92 mm		DO (NO)	SGR 1-125-012-B1-A-04-3F	
		1430 mm	32	154	46 mm		LO (NC)	SGR 1-125-012-B1-A-05-3F	
	2000 mm	1755 mm	20	94	92 mm		DO (NO)	SGR 1-125-024-A1-A-04-3F	
		1800 mm	40	194	46 mm		LO (NC)	SGR 1-125-024-A1-A-05-3F	
	2100 mm	1755 mm	20	94	92 mm		DO (NO)	SGR 1-160-016-B1-A-04-3F	
		1800 mm	40	194	46 mm		LO (NC)	SGR 1-160-016-B1-A-05-3F	
	2000 mm	1755 mm	20	94	92 mm		DO (NO)	SGR 1-160-032-A1-A-04-3F	
		1800 mm	40	194	46 mm		LO (NC)	SGR 1-160-032-A1-A-05-3F	
	2000 mm	1755 mm	20	94	92 mm		DO (NO)	SGR 1-200-020-B1-A-04-3F	
		1800 mm	40	194	46 mm		LO (NC)	SGR 1-200-020-B1-A-05-3F	
	2100 mm	1755 mm	20	94	92 mm		DO (NO)	SGR 1-200-040-A1-A-04-3F	
		1800 mm	40	194	46 mm		LO (NC)	SGR 1-200-040-A1-A-05-3F	
2100 mm	1755 mm	20	94	92 mm	DO (NO)	SGR 1-210-020-B1-A-04-3F			
	1800 mm	40	194	46 mm	LO (NC)	SGR 1-210-020-B1-A-05-3F			
2100 mm	1755 mm	20	94	92 mm	DO (NO)	SGR 1-210-040-A1-A-04-3F			
	1800 mm	40	194	46 mm	LO (NC)	SGR 1-210-040-A1-A-05-3F			

- Note:**
- The transmitter SGT and receiver SGR set must have the same number of channels and beam spacing
 - The transmitter SGT is available in a long range model to be used in conjunction with standard receiver SGR. Sensing range is increased by 50%. Add "H" after the series number of the SGT for long range model, e.g. SGT 1H-200-040-A1-A-00-3F

Available Types

Leading Edge B

	Housing Length	Active Height	Number of Channels	Number of Beams	Beam Spacing	Connection		3 m flexible cable	Range
						Output		Order Reference	
Transmitter Detector	850 mm	650 mm	8	34	92 mm	-	-	SGT 1-085-008-B1-B-00-3F	3 m
		695 mm	16	74	46 mm			SGT 1-085-016-A1-B-00-3F	
	1250 mm	1020 mm	12	54	92 mm			SGT 1-125-012-B1-B-00-3F	
		1065 mm	24	114	46 mm			SGT 1-125-024-A1-B-00-3F	
	1600 mm	1385 mm	16	74	92 mm			SGT 1-160-016-B1-B-00-3F	
		1430 mm	32	154	46 mm			SGT 1-160-032-A1-B-00-3F	
	2000 mm	1755 mm	20	94	92 mm			SGT 1-200-020-B1-B-00-3F	
		1800 mm	40	194	46 mm			SGT 1-200-040-A1-B-00-3F	
	2100 mm	1755 mm	20	94	92 mm			SGT 1-210-020-B1-B-00-3F	
		1800 mm	40	194	46 mm			SGT 1-210-040-A1-B-00-3F	

	Housing Length	Active Height	Number of Channels	Number of Beams	Beam Spacing	Solid State Relay	Connection		Order Reference	Range
							DO (NO)	LO (NC)		
Receiver Detector	850 mm	650 mm	8	34	92 mm	Solid State Relay	DO (NO)	SGR 1-085-008-B1-B-04-3F	0-3 m	
		695 mm	16	74	46 mm		LO (NC)	SGR 1-085-008-B1-B-05-3F		
	1250 mm	1020 mm	12	54	92 mm		DO (NO)	SGR 1-085-016-A1-B-04-3F		
		1065 mm	24	114	46 mm		LO (NC)	SGR 1-085-016-A1-B-05-3F		
	1600 mm	1385 mm	16	74	92 mm		DO (NO)	SGR 1-125-012-B1-B-04-3F		
		1430 mm	32	154	46 mm		LO (NC)	SGR 1-125-012-B1-B-05-3F		
	2000 mm	1755 mm	20	94	92 mm		DO (NO)	SGR 1-125-024-A1-B-04-3F		
		1800 mm	40	194	46 mm		LO (NC)	SGR 1-125-024-A1-B-05-3F		
	2100 mm	1755 mm	20	94	92 mm		DO (NO)	SGR 1-160-016-B1-B-04-3F		
		1800 mm	40	194	46 mm		LO (NC)	SGR 1-160-016-B1-B-05-3F		
	2000 mm	1755 mm	20	94	92 mm		DO (NO)	SGR 1-160-032-A1-B-04-3F		
		1800 mm	40	194	46 mm		LO (NC)	SGR 1-160-032-A1-B-05-3F		
	2000 mm	1755 mm	20	94	92 mm		DO (NO)	SGR 1-200-020-B1-B-04-3F		
		1800 mm	40	194	46 mm		LO (NC)	SGR 1-200-020-B1-B-05-3F		
	2100 mm	1755 mm	20	94	92 mm		DO (NO)	SGR 1-200-040-A1-B-04-3F		
		1800 mm	40	194	46 mm		LO (NC)	SGR 1-200-040-A1-B-05-3F		
2100 mm	1755 mm	20	94	92 mm	DO (NO)	SGR 1-210-020-B1-B-04-3F				
	1800 mm	40	194	46 mm	LO (NC)	SGR 1-210-020-B1-B-05-3F				
2100 mm	1755 mm	20	94	92 mm	DO (NO)	SGR 1-210-040-A1-B-04-3F				
	1800 mm	40	194	46 mm	LO (NC)	SGR 1-210-040-A1-B-05-3F				

- Note:**
- The transmitter SGT and receiver SGR set must have the same number of channels and beam spacing
 - The transmitter SGT is available in a long range model to be used in conjunction with standard receiver SGR. Sensing range is increased by 50%. Add "H" after the series number of the SGT for long range model, e.g. SGT 1H-200-040-A1-B-00-3F

Available Types

Slim Line C

Transmitter Detector	Housing Length	Active Height	Number of Channels	Number of Beams	Beam Spacing	Connection		3 m flexible cable	Range
						Output	Order Reference		
	850 mm	650 mm	8	34	92 mm	-	-	SGT 1-085-008-B1-C-00-3F	4 m
		695 mm	16	74	46 mm			SGT 1-085-016-A1-C-00-3F	
	1250 mm	1020 mm	12	54	92 mm			SGT 1-125-012-B1-C-00-3F	
		1065 mm	24	114	46 mm			SGT 1-125-024-A1-C-00-3F	
	1600 mm	1385 mm	16	74	92 mm			SGT 1-160-016-B1-C-00-3F	
		1430 mm	32	154	46 mm			SGT 1-160-032-A1-C-00-3F	
	2000 mm	1755 mm	20	94	92 mm			SGT 1-200-020-B1-C-00-3F	
		1800 mm	40	194	46 mm			SGT 1-200-040-A1-C-00-3F	

Receiver Detector	Housing Length	Active Height	Number of Channels	Number of Beams	Beam Spacing	Solid State Relay	Connection		Range
							Output	Order Reference	
	850 mm	650 mm	8	34	92 mm		DO (NO)	SGR 1-085-008-B1-C-04-3F	0-4 m
		695 mm	16	74	46 mm		LO (NC)	SGR 1-085-008-B1-C-05-3F	
	1250 mm	1020 mm	12	54	92 mm		DO (NO)	SGR 1-125-016-A1-C-04-3F	
		1065 mm	24	114	46 mm		LO (NC)	SGR 1-125-016-A1-C-05-3F	
	1600 mm	1385 mm	16	74	92 mm		DO (NO)	SGR 1-125-012-B1-C-04-3F	
		1430 mm	32	154	46 mm		LO (NC)	SGR 1-125-012-B1-C-05-3F	
	2000 mm	1755 mm	20	94	92 mm		DO (NO)	SGR 1-125-024-A1-C-04-3F	
		1800 mm	40	194	46 mm		LO (NC)	SGR 1-125-024-A1-C-05-3F	
	1600 mm	1385 mm	16	74	92 mm		DO (NO)	SGR 1-160-016-B1-C-04-3F	
		1430 mm	32	154	46 mm		LO (NC)	SGR 1-160-016-B1-C-05-3F	
	2000 mm	1755 mm	20	94	92 mm		DO (NO)	SGR 1-160-032-A1-C-04-3F	
		1800 mm	40	194	46 mm		LO (NC)	SGR 1-160-032-A1-C-05-3F	
	1600 mm	1385 mm	16	74	92 mm		DO (NO)	SGR 1-200-020-B1-C-04-3F	
		1430 mm	32	154	46 mm		LO (NC)	SGR 1-200-020-B1-C-05-3F	
	2000 mm	1755 mm	20	94	92 mm		DO (NO)	SGR 1-200-040-A1-C-04-3F	
		1800 mm	40	194	46 mm		LO (NC)	SGR 1-200-040-A1-C-05-3F	

- Note: 1. The transmitter SGT and receiver SGR set must have the same number of channels and beam spacing
 2. The transmitter SGT is available in a long range model to be used in conjunction with standard receiver SGR. Sensing range is increased by 50%.
 Add "H" after the series number of the SGT for long range model, e.g. SGT 1H-200-040-A1-C-00-3F

Wiring Diagrams

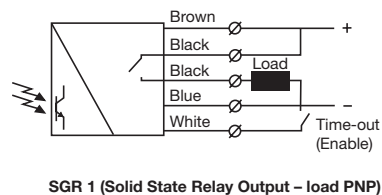
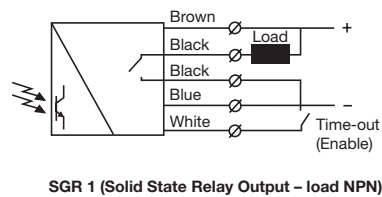
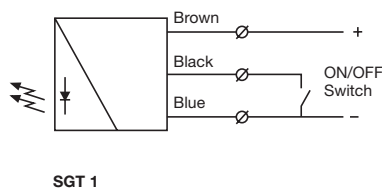

Dimensions and Descriptions

Slim Line A

Details

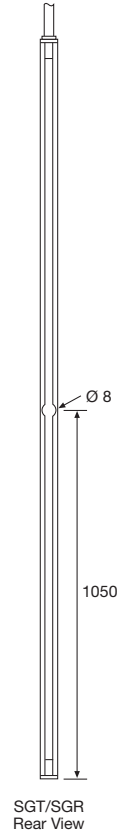
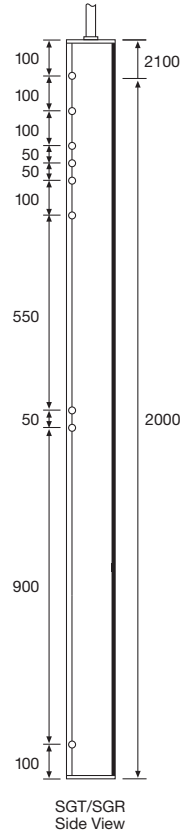
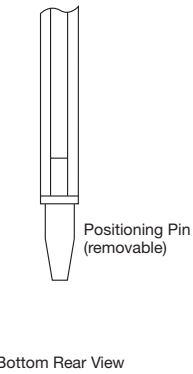
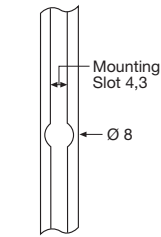
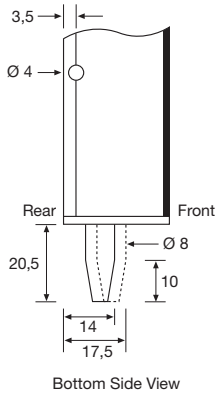
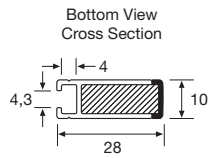
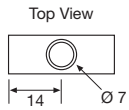
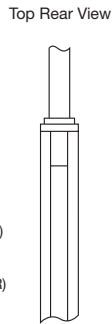
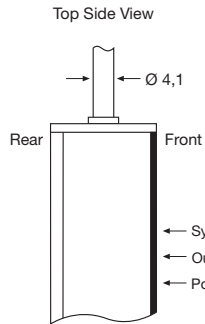

SGT/SGR 1-200/210

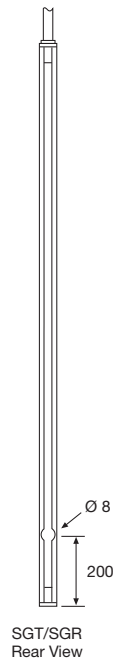
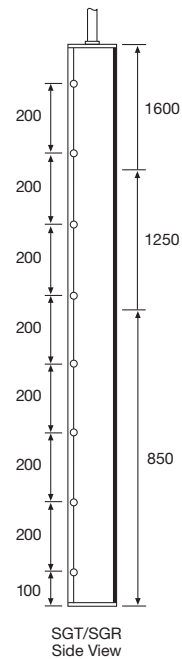

SGT/SGR 1-085/125/160

(Units in mm)

Dimensions and Descriptions

Leading Edge B

Details

SGT
Top Front View
(shown with screw cover strip)

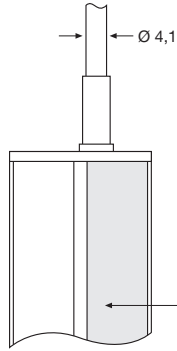

SGR
Top Front View
(shown without screw cover strip)

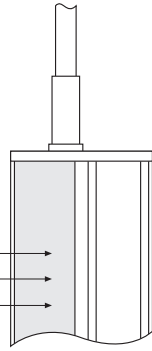

System status indicator
Output indicator
Power on indicator

Top View

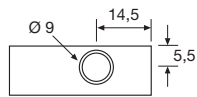

Top View

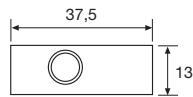

Bottom View
Cross Section

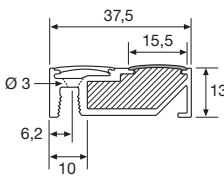

Bottom View
Cross Section

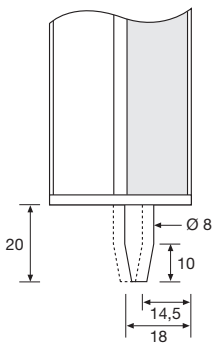

Bottom Front View

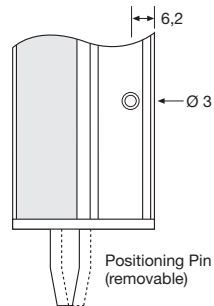

Bottom Front View

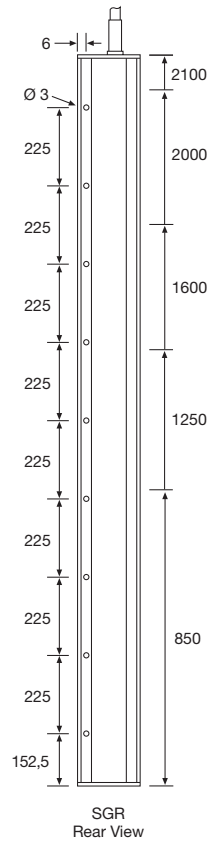

SGR
Rear View

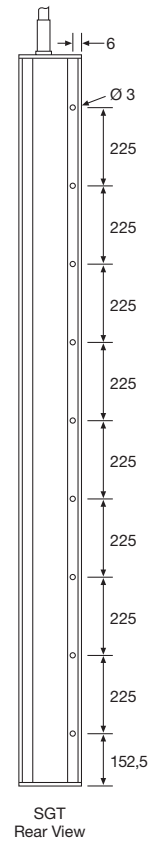

SGT
Rear View

(Units in mm)

Dimensions and Descriptions

Slim Line C

Details

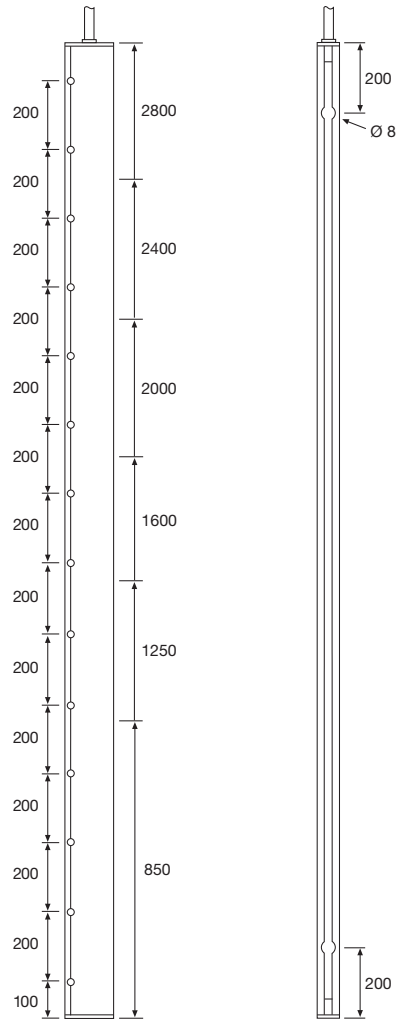
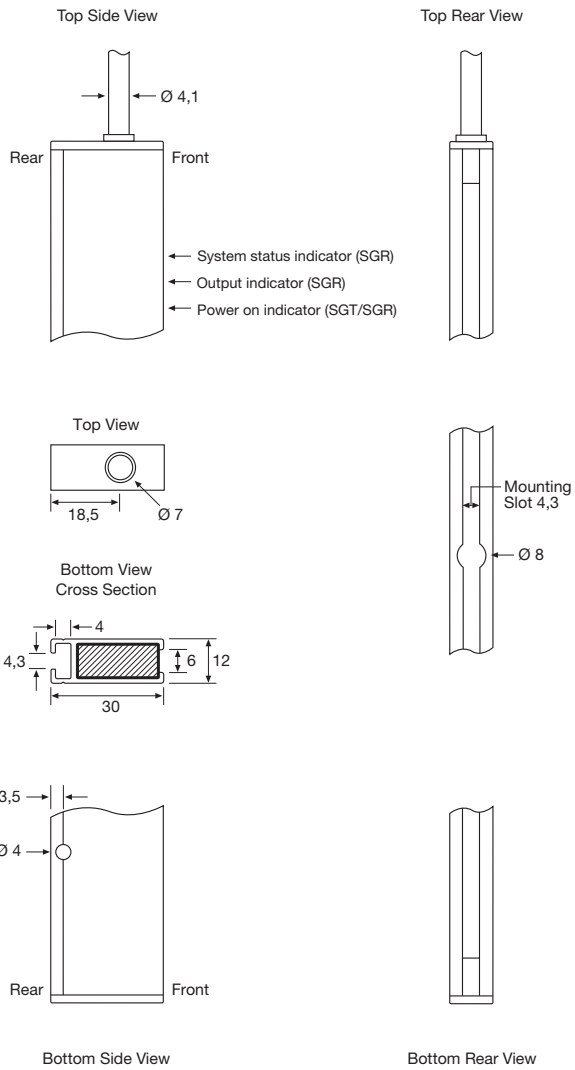

(Units in mm)

Beam Patterns

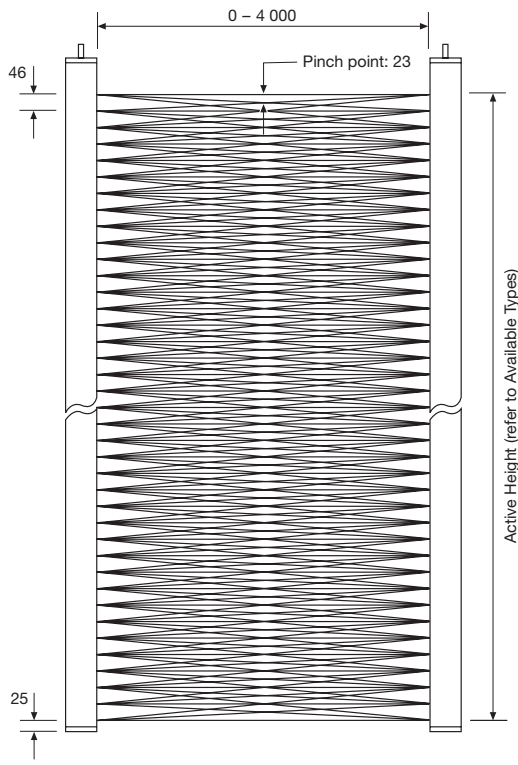

46 mm channel spacing

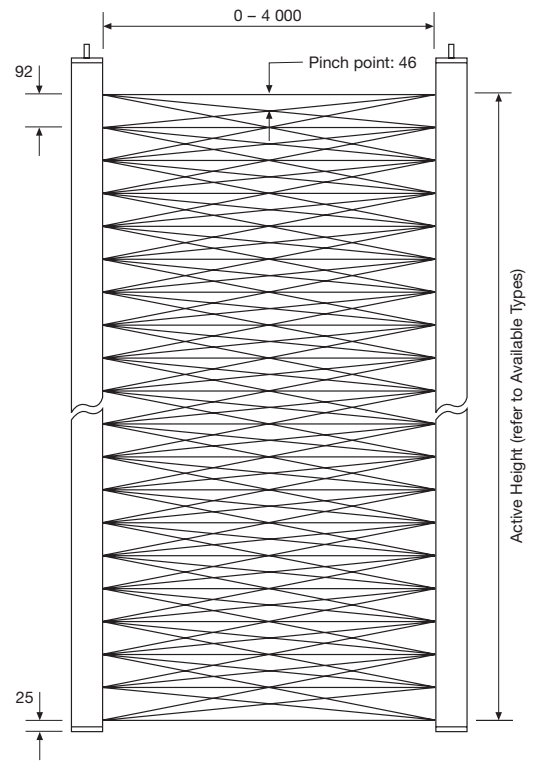

92 mm channel spacing

(Units in mm)

Sensing Characteristics

Parallel Displacement

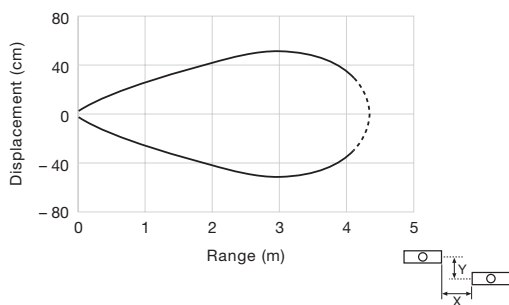

Slim Line A / C

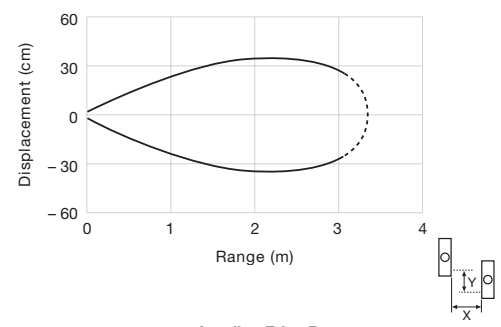

Leading Edge B

Telco reserves the right to change specifications without notice.

Description

- 0-4 m sensing range
- 94 cross scanning beams
- Active height of 1800 mm
- Detector length 2000 mm or 2100 mm
- Flexible cable connection
- Automatic sensitivity adjustment
- Slim line (10x28 mm) detector housing
- Power, output and signal status indicators
- 12-36 V dc supply voltage
- Blanking function of up to 10 channels
- 5 wire, solid state relay output
- Test input
- Light/dark function via wire connection



The SG 2 light curtain system is designed for modernisation of elevator doors and consists of a self-contained transmitter detector, SGT and receiver detector, SGR, which are to be positioned opposite of each other. The detectors are housed in an aluminium profile available in a slim line design (10 x 28 mm).

The SGR is supplied with a 12-36 V dc power supply with a 5 wire, solid state relay output and with wire selectable light or dark function. The test input in the SGT may be used for either disabling or enabling the transmitting power temporarily for test purposes.

The detectors are available with time-out function which allows up to 2 non-adjacent channels to be ignored if permanently obstructed for 10 seconds or more.

The advanced automatic signal-tracking (AST) feature ensures that no onsite set up or adjustments are required. The signal level of each individual channel is adjusted automatically compensating for misalignment and contamination during operation. Transmitter and receiver detectors are optically synchronised. The system can be used both in static and dynamic applications.

The special blanking function allows up to 10 top channels to be ignored when covered/masked during set up. This feature allows the active height to be reduced for applications which do not allow the full detection height.

Both the transmitter and receiver detectors are protected against reverse polarity of power supplies, control input and output signals. The output is also protected against short circuit and inductive loads.

Technical Data			SGT	SGR
Supply voltage			12-36 V dc	
Current consumption			Max. 100 mA	50 mA
Output rating	Solid state		–	200 mA
Short circuit protected			–	Yes
Reverse polarity protected			Yes	
Light source			Infrared (940 nm)	–
Number of channels (diodes per detector)			20	
Number of cross scanning beams			94	
Active height			1800 mm	
Channel spacing			Between Ch 1 and Ch 19: 92 mm	
			Between Ch 19 and Ch 20: 138 mm	
Bottom spacing to Ch 1			25 mm	
Pinch point beam spacing			46 mm	
Response time			–	< 40 ms
Power on indicator			Green LED	
Output indicator			–	Yellow LED
System status indicator			–	Red LED
Time-out function			Up to 2 non-adjacent channels	
Housing dimensions (w x d)	Slim Line	A	10 x 28 mm	
Housing material	Profile		Aluminium (natural anodised)	
	Lens cover		Polycarbonate	
Connection			3 m fixed flexible cable	
Cable, PVC Ø 4,1 mm			3 x 0,14 mm ²	5 x 0,14 mm ²

Environmental Data

		SGT	SGR
Light immunity @ 5° incidence		-	> 100 000 lux
Temperature, operation		-20 to +65 °C	
Temperature, storage		-40 to +80 °C	
Sealing class	A housing	IP 54	
Approvals		CE	

Available Types

Slim Line A

Transmitter	Housing Length	Active Height	Number of Channels	Number of Beams	Time-Out Function	Connection		3 m flexible cable	Range
						Output		Order Reference	
Transmitter	2000 mm	1800 mm	20	94	-	-	-	SGT 2-200-020-010-B1-A-00-3F	4 m
	2100 mm							SGT 2-210-020-010-B1-A-00-3F	
Receiver	2000 mm	1800 mm	20	94	Time-Out	Solid State Relay	DO/LO (NO/NC)	SGR 2-200-020-010-B1-A-06-3F	0-4 m
	2100 mm				SGR 2-210-020-010-B1-A-06-3F				
	2000 mm				SGR 2-200-020-010-B1-A-07-3F				
	2100 mm				SGR 2-210-020-010-B1-A-07-3F				

Wiring Diagrams

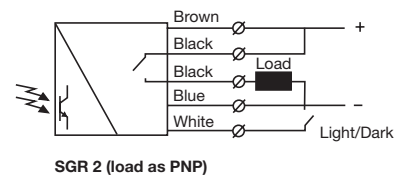
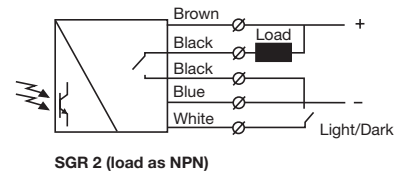
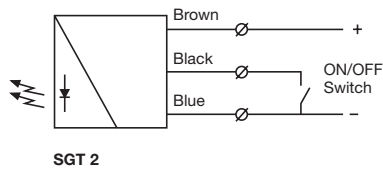

Dimensions and Descriptions

Slim Line A

Details

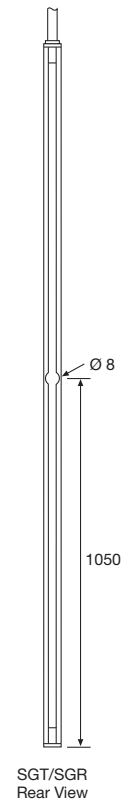
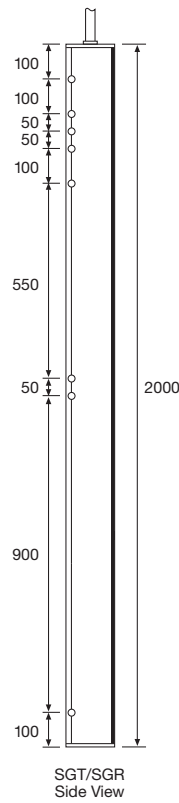
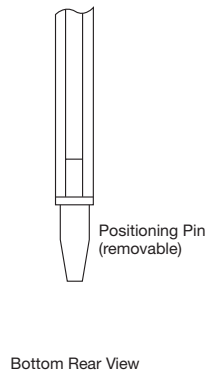
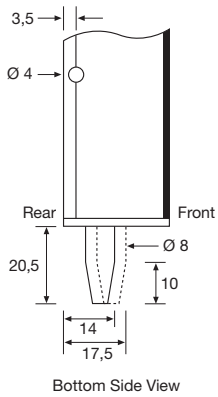
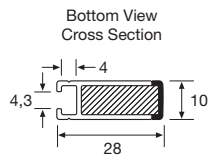
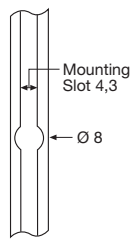
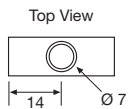
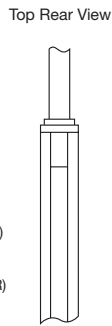
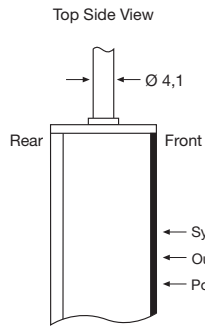

SGT/SGR 2-200

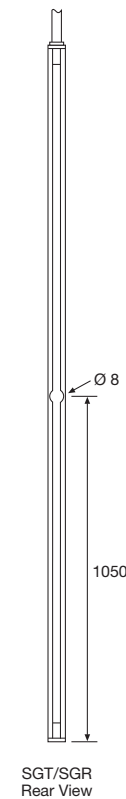
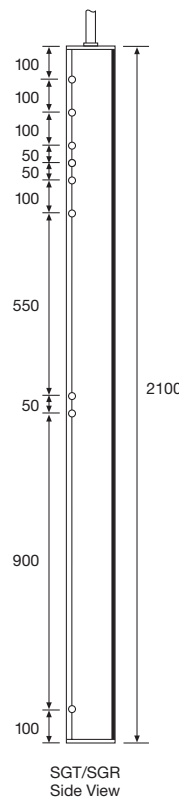

SGT/SGR 2-210

(Units in mm)

Beam Patterns

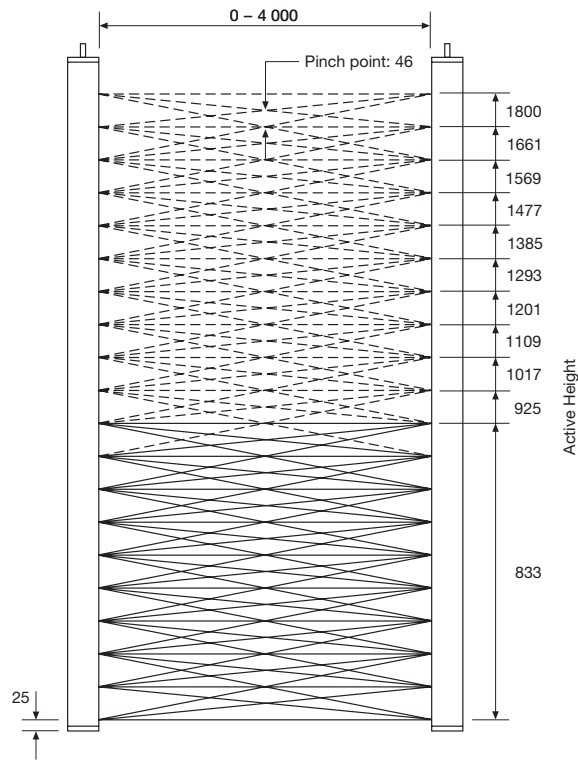

(Units in mm)

Sensing Characteristics

Parallel Displacement

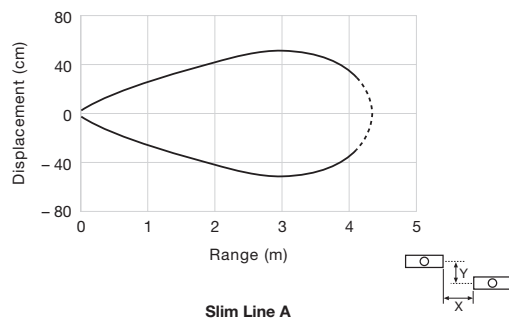

Telco reserves the right to change specifications without notice.

Description

- 1-10 m sensing range
- 34 to 274 cross scanning beams
- Active height of 650 mm to 2535 mm
- Detector length of 850 mm to 2800 mm
- Cable or plug connection
- Automatic sensitivity adjustment
- Water-resistant, slim line (12x30 mm) detector housing
- Power, output and signal status indicators
- 12-36 V dc supply voltage
- 5 wire, solid state relay output
- Test input
- Light/dark function via wire connection



The SG 10 light curtain system consists of a self-contained transmitter detector, SGT and receiver detector, SGR, which are to be positioned opposite of each other. The detectors are housed in a water-resistant, aluminium profile available in a slim line design (12 x 30 mm).

The SGR is supplied with a 12-36 V dc power supply with a 5 wire, solid state relay output, with wire selectable light or dark function. The test input in the SGT may be used for either disabling or enabling the transmitting power temporarily for test purposes.

The advanced automatic signal-tracking (AST) feature ensures that no onsite set up or adjustments are required. The signal level of each

individual channel is adjusted automatically, which compensates for misalignment and contamination during operation. Transmitter and receiver detectors are optically synchronised.

Specialised signal processing technology, designed for outdoor environments, reduces the risk of false detections of water, rain or snow that may pass between the detectors during operation.

Both the transmitter and receiver detectors are protected against reverse polarity of power supplies, control input and output signals. The output is also protected against short circuit and inductive loads.

Technical Data					
		46 mm channel spacing		92 mm channel spacing	
		SGT	SGR	SGT	SGR
Supply voltage		12-36 V dc			
Current consumption		Max. 100 mA	50 mA	Max. 100 mA	50 mA
Output rating		Solid state		Solid state	
		-	200 mA	-	200 mA
Short circuit protected		-	Yes	-	Yes
Reverse polarity protected		Yes			
Light source		Infrared (880 nm)	-	Infrared (880 nm)	-
Number of channels (diodes per detector)		16, 24, 32, 40, 48 or 56		8, 12, 16, 20, 24 or 28	
Number of cross scanning beams		74, 114, 154, 194, 234 or 274		34, 54, 74, 94, 114 or 134	
Active height		695, 1065, 1430, 1800, 2165 or 2535 mm		650, 1020, 1385, 1755, 2120 or 2490 mm	
Channel spacing		46 mm		92 mm	
Bottom spacing to Ch 1		25 mm			
Pinch point beam spacing		23 mm		46 mm	
Response time		-	< 165 ms	-	< 85 ms
Power on indicator		Green LED			
Output indicator		-	Yellow LED	-	Yellow LED
System status indicator		-	Red LED	-	Red LED
Time-out function		-			
Housing dimensions (w x d)		Slim Line C		12 x 30 mm	
Housing material		Aluminium (black anodised)			
Lens cover		Polycarbonate			
Connection		5 m fixed cable or 0,5 m cable with 5 pin, M12 plug			
Cable, PVC Ø 4,9 mm		3 x 0,20 mm ²	5 x 0,20 mm ²	3 x 0,20 mm ²	5 x 0,20 mm ²

Environmental Data

		SGT	SGR
Light immunity @ 5° incidence		-	> 100 000 lux
Temperature, operation		-20 to +65 °C	
Temperature, storage		-40 to +80 °C	
Sealing class C housing		IP 67	
Approvals		CE	

Available Types

Slim Line C

	Housing Length	Active Height	Number of Channels	Number of Beams	Beam Spacing	Connection		5 m cable	0.5 m cable with 5 pin, M12 plug	Range				
						Output		Order Reference						
Transmitter Detector	850 mm	650 mm	8	34	92 mm	-	-	SGT 10-085-008-B1-C-01-5	SGT 10-085-008-B1-C-01-0.5-J5	10 m				
		695 mm	16	74	46 mm			SGT 10-085-016-A1-C-01-5	SGT 10-085-016-A1-C-01-0.5-J5					
	1250 mm	1020 mm	12	54	92 mm			SGT 10-125-012-B1-C-01-5	SGT 10-125-012-B1-C-01-0.5-J5					
		1065 mm	24	114	46 mm			SGT 10-125-024-A1-C-01-5	SGT 10-125-024-A1-C-01-0.5-J5					
	1600 mm	1385 mm	16	74	92 mm			SGT 10-160-016-B1-C-01-5	SGT 10-160-016-B1-C-01-0.5-J5					
		1430 mm	32	154	46 mm			SGT 10-160-032-A1-C-01-5	SGT 10-160-032-A1-C-01-0.5-J5					
	2000 mm	1755 mm	20	94	92 mm			SGT 10-200-020-B1-C-01-5	SGT 10-200-020-B1-C-01-0.5-J5					
		1800 mm	40	194	46 mm			SGT 10-200-040-A1-C-01-5	SGT 10-200-040-A1-C-01-0.5-J5					
	2400 mm	2120 mm	24	114	92 mm			SGT 10-240-024-B1-C-01-5	SGT 10-240-024-B1-C-01-0.5-J5					
		2165 mm	48	234	46 mm			SGT 10-240-048-A1-C-01-5	SGT 10-240-048-A1-C-01-0.5-J5					
	2800 mm	2490 mm	28	134	92 mm			SGT 10-280-028-B1-C-01-5	SGT 10-280-028-B1-C-01-0.5-J5					
		2535 mm	56	274	46 mm			SGT 10-280-056-A1-C-01-5	SGT 10-280-056-A1-C-01-0.5-J5					
	Receiver Detector	850 mm	650 mm	8	34			92 mm	Solid State Relay		DO/LO (NO/NC)	SGR 10-085-008-B1-C-07-5	SGR 10-085-008-B1-C-07-0.5-J5	1-10 m
			695 mm	16	74			46 mm				SGR 10-085-016-A1-C-07-5	SGR 10-085-016-A1-C-07-0.5-J5	
1250 mm		1020 mm	12	54	92 mm	SGR 10-125-012-B1-C-07-5	SGR 10-125-012-B1-C-07-0.5-J5							
		1065 mm	24	114	46 mm	SGR 10-125-024-A1-C-07-5	SGR 10-125-024-A1-C-07-0.5-J5							
1600 mm		1385 mm	16	74	92 mm	SGR 10-160-016-B1-C-07-5	SGR 10-160-016-B1-C-07-0.5-J5							
		1430 mm	32	154	46 mm	SGR 10-160-032-A1-C-07-5	SGR 10-160-032-A1-C-07-0.5-J5							
2000 mm		1755 mm	20	94	92 mm	SGR 10-200-020-B1-C-07-5	SGR 10-200-020-B1-C-07-0.5-J5							
		1800 mm	40	194	46 mm	SGR 10-200-040-A1-C-07-5	SGR 10-200-040-A1-C-07-0.5-J5							
2400 mm		2120 mm	24	114	92 mm	SGR 10-240-024-B1-C-07-5	SGR 10-240-024-B1-C-07-0.5-J5							
		2165 mm	48	234	46 mm	SGR 10-240-048-A1-C-07-5	SGR 10-240-048-A1-C-07-0.5-J5							
2800 mm		2490 mm	28	134	92 mm	SGR 10-280-028-B1-C-07-5	SGR 10-280-028-B1-C-07-0.5-J5							
		2535 mm	56	274	46 mm	SGR 10-280-056-A1-C-07-5	SGR 10-280-056-A1-C-07-0.5-J5							

Note: The transmitter SGT and receiver SGR set must have the same number of channels and beam spacing.

Connections

	Cable	M12 Plug / Cable
Supply +	Brown	Pin 1 / Brown
Supply -	Blue	Pin 3 / Blue
SGT test input	Black	Pin 4 / Black
SGR output	Black	Pin 4 / Black
SGR output	Black	Pin 5 / Grey
SGR DO/LO control	White	Pin 2 / White

5 pin, M12

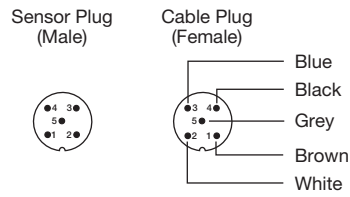

Refer to page 161 for extension cables

Wiring Diagrams

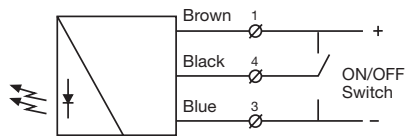

SGT 10
Connect black test input wire to + or - to disable SGT

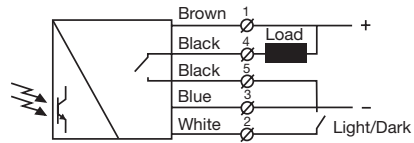

SGR 10 (load as NPN)

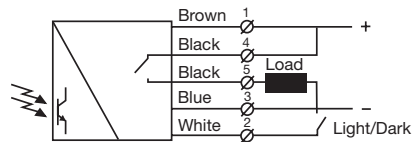

SGR 10 (load as PNP)

Beam Patterns

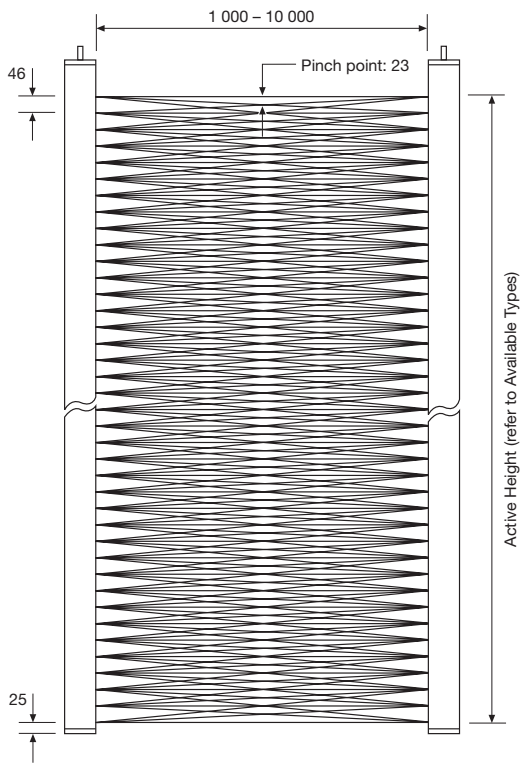

46 mm channel spacing

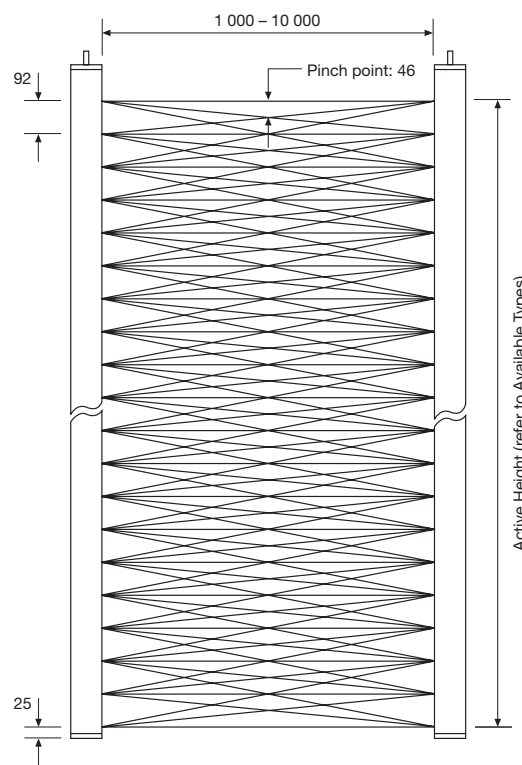

92 mm channel spacing

(Units in mm)

Sensing Characteristics

Parallel Displacement

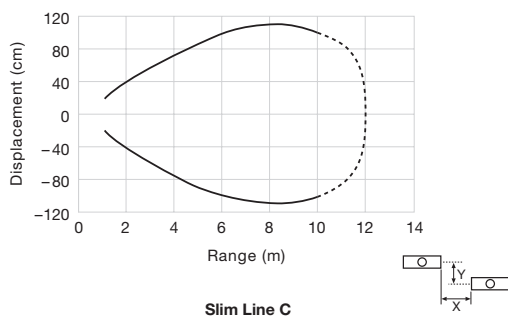

Telco reserves the right to change specifications without notice.

Description

- 1-10 m sensing range
- 16 to 56 parallel beams
- Active height of 695 mm to 2535 mm
- Detector length of 850 mm to 2800 mm
- Cable or plug connection
- Automatic sensitivity adjustment
- Water-resistant slim line (12x30 mm) or leading edge (38,4x14 mm) detector housing
- Power, output and signal status indicators
- 12-36 V dc supply voltage
- 5 wire, solid state relay output
- Test input
- Dynamic sequential blanking function



The SG 14 light curtain system consists of a self-contained transmitter detector, SGT and receiver detector, SGR, which are to be positioned opposite of each other. The detectors are housed in a sturdy aluminium profile available in a slim line design (12 x 30 mm) or a leading edge design (38,4 x 14 mm).

The SGR is supplied with a 12-36 V dc power supply with a 5 wire, solid state relay output, with wire selectable dynamic blanking function. The test input in the SGT may be used for either disabling or enabling the transmitting power temporarily for test purposes.

The advanced automatic signal-tracking (AST) feature ensures that no onsite set up or adjustments are required. The signal level of each individual channel is adjusted automatically, which compensates for

misalignment and contamination during operation. Transmitter and receiver detectors are optically synchronised.

The SG 14 series features the Dynamic Sequential Blanking Function which allows the detectors to be positioned in the guide tracks of an industrial door, where the door travels directly in front of the protection area, interrupting the beams sequentially from top to bottom. The special feature ensures that the system can distinguish between the closing door and an object by ignoring the beams that are obstructed by the moving door whilst leaving the below remaining beams active to detect an object in the protection area.

Both the transmitter and receiver detectors are protected against reverse polarity of power supplies, control input and output signals. The output is also protected against short circuit and inductive loads.

Technical Data		SGT	SGR
Supply voltage		12-36 V dc	
Current consumption		Max. 70 mA	50 mA
Output rating	Solid state	-	200 mA
Short circuit protected		-	Yes
Reverse polarity protected		Yes	
Light source		Infrared (880 nm)	-
Number of channels (diodes per detector)		16, 24, 32, 40, 48 or 56	
Number of parallel beams		16, 24, 32, 40, 48 or 56	
Active height		695, 1065, 1430, 1800, 2165 or 2535 mm	
Channel spacing		46 mm	
Bottom spacing to Ch 1		25 mm	
Response time		-	16/24 chs: 24 ms 32 chs: 30 ms 40 chs: 37 ms 48 chs: 43 ms 56 chs: 49 ms
Max. / min. sequential blanking speed		1,6 m/s / 0,05 m/s	
Minimum size of blanking object		55 mm	
Power on indicator		Green LED	
Output indicator		-	Yellow LED
System status indicator		-	Red LED
Time-out function		-	
Housing dimensions (w x d)	Slim Line C	12 x 30 mm	
	Leading Edge D	38,4 x 14 mm	
Housing material	Profile	Aluminium (black anodised)	
	Lens cover	Polycarbonate	
Connection		5 m fixed cable or 5 pin, M12 plug	
Cable, PVC Ø 4,9 mm		3 x 0,20 mm ²	5 x 0,20 mm ²

Environmental Data

		SGT	SGR
Light immunity @ 5° incidence		-	> 100 000 lux
Temperature, operation		-20 to +65 °C	
Temperature, storage		-40 to +80 °C	
Sealing class C / D housing		IP 67	
Approvals		CE	

Available Types

Slim Line C

Transmitter Detector	Housing Length	Active Height	Number of Channels	Beam Spacing	Connection		5 m cable	0.5 m cable with 5 pin, M12 plug	Range
					Output		Order Reference		
					-	-	SGT	SGR	
Transmitter Detector	850 mm	695 mm	16	46 mm	-	-	SGT 14-085-016-A1-C-01-5	SGT 14-085-016-A1-C-01-0.5-J5	10 m
	1250 mm	1065 mm	24				SGT 14-125-024-A1-C-01-5	SGT 14-125-024-A1-C-01-0.5-J5	
	1600 mm	1430 mm	32				SGT 14-160-032-A1-C-01-5	SGT 14-160-032-A1-C-01-0.5-J5	
	2000 mm	1800 mm	40				SGT 14-200-040-A1-C-01-5	SGT 14-200-040-A1-C-01-0.5-J5	
	2400 mm	2165 mm	48				SGT 14-240-048-A1-C-01-5	SGT 14-240-048-A1-C-01-0.5-J5	
	2800 mm	2535 mm	56				SGT 14-280-056-A1-C-01-5	SGT 14-280-056-A1-C-01-0.5-J5	

Receiver Detector	Housing Length	Active Height	Number of Channels	Beam Spacing	Solid State Relay	Connection		5 m cable	0.5 m cable with 5 pin, M12 plug	1-10 m					
						Output		DO (NO)	LO (NC)		SGT	SGR			
						850 mm	695 mm	16	46 mm		Solid State Relay	DO (NO)	LO (NC)	SGR 14-085-016-A1-C-08-5	SGR 14-085-016-A1-C-08-0.5-J5
												LO (NC)	DO (NO)	SGR 14-085-016-A1-C-09-5	SGR 14-085-016-A1-C-09-0.5-J5
						1250 mm	1065 mm	24	46 mm		Solid State Relay	DO (NO)	LO (NC)	SGR 14-125-024-A1-C-08-5	SGR 14-125-024-A1-C-08-0.5-J5
												LO (NC)	DO (NO)	SGR 14-125-024-A1-C-09-5	SGR 14-125-024-A1-C-09-0.5-J5
						1600 mm	1430 mm	32	46 mm		Solid State Relay	DO (NO)	LO (NC)	SGR 14-160-032-A1-C-08-5	SGR 14-160-032-A1-C-08-0.5-J5
												LO (NC)	DO (NO)	SGR 14-160-032-A1-C-09-5	SGR 14-160-032-A1-C-09-0.5-J5
						2000 mm	1800 mm	40	46 mm		Solid State Relay	DO (NO)	LO (NC)	SGR 14-200-040-A1-C-08-5	SGR 14-200-040-A1-C-08-0.5-J5
												LO (NC)	DO (NO)	SGR 14-200-040-A1-C-09-5	SGR 14-200-040-A1-C-09-0.5-J5
2400 mm	2165 mm	48	46 mm	Solid State Relay	DO (NO)	LO (NC)	SGR 14-240-048-A1-C-08-5	SGR 14-240-048-A1-C-08-0.5-J5							
					LO (NC)	DO (NO)	SGR 14-240-048-A1-C-09-5	SGR 14-240-048-A1-C-09-0.5-J5							
2800 mm	2535 mm	56	46 mm	Solid State Relay	DO (NO)	LO (NC)	SGR 14-280-056-A1-C-08-5	SGR 14-280-056-A1-C-08-0.5-J5							
					LO (NC)	DO (NO)	SGR 14-280-056-A1-C-09-5	SGR 14-280-056-A1-C-09-0.5-J5							

Leading Edge D

Transmitter Detector	Housing Length	Active Height	Number of Channels	Beam Spacing	Connection		5 m cable	0.5 m cable with 5 pin, M12 plug	Range
					Output		Order Reference		
					-	-	SGT	SGR	
Transmitter Detector	850 mm	695 mm	16	46 mm	-	-	SGT 14-085-016-A1-D-01-5	SGT 14-085-016-A1-D-01-0.5-J5	7,5 m
	1250 mm	1065 mm	24				SGT 14-125-024-A1-D-01-5	SGT 14-125-024-A1-D-01-0.5-J5	
	1600 mm	1430 mm	32				SGT 14-160-032-A1-D-01-5	SGT 14-160-032-A1-D-01-0.5-J5	
	2000 mm	1800 mm	40				SGT 14-200-040-A1-D-01-5	SGT 14-200-040-A1-D-01-0.5-J5	
	2400 mm	2165 mm	48				SGT 14-240-048-A1-D-01-5	SGT 14-240-048-A1-D-01-0.5-J5	
	2800 mm	2535 mm	56				SGT 14-280-056-A1-D-01-5	SGT 14-280-056-A1-D-01-0.5-J5	

Receiver Detector	Housing Length	Active Height	Number of Channels	Beam Spacing	Solid State Relay	Connection		5 m cable	0.5 m cable with 5 pin, M12 plug	1-7,5 m					
						Output		DO (NO)	LO (NC)		SGT	SGR			
						850 mm	695 mm	16	46 mm		Solid State Relay	DO (NO)	LO (NC)	SGR 14-085-016-A1-D-08-5	SGR 14-085-016-A1-D-08-0.5-J5
												LO (NC)	DO (NO)	SGR 14-085-016-A1-D-09-5	SGR 14-085-016-A1-D-09-0.5-J5
						1250 mm	1065 mm	24	46 mm		Solid State Relay	DO (NO)	LO (NC)	SGR 14-125-024-A1-D-08-5	SGR 14-125-024-A1-D-08-0.5-J5
												LO (NC)	DO (NO)	SGR 14-125-024-A1-D-09-5	SGR 14-125-024-A1-D-09-0.5-J5
						1600 mm	1430 mm	32	46 mm		Solid State Relay	DO (NO)	LO (NC)	SGR 14-160-032-A1-D-08-5	SGR 14-160-032-A1-D-08-0.5-J5
												LO (NC)	DO (NO)	SGR 14-160-032-A1-D-09-5	SGR 14-160-032-A1-D-09-0.5-J5
						2000 mm	1800 mm	40	46 mm		Solid State Relay	DO (NO)	LO (NC)	SGR 14-200-040-A1-D-08-5	SGR 14-200-040-A1-D-08-0.5-J5
												LO (NC)	DO (NO)	SGR 14-200-040-A1-D-09-5	SGR 14-200-040-A1-D-09-0.5-J5
2400 mm	2165 mm	48	46 mm	Solid State Relay	DO (NO)	LO (NC)	SGR 14-240-048-A1-D-08-5	SGR 14-240-048-A1-D-08-0.5-J5							
					LO (NC)	DO (NO)	SGR 14-240-048-A1-D-09-5	SGR 14-240-048-A1-D-09-0.5-J5							
2800 mm	2535 mm	56	46 mm	Solid State Relay	DO (NO)	LO (NC)	SGR 14-280-056-A1-D-08-5	SGR 14-280-056-A1-D-08-0.5-J5							
					LO (NC)	DO (NO)	SGR 14-280-056-A1-D-09-5	SGR 14-280-056-A1-D-09-0.5-J5							

Note: The transmitter SGT and receiver SGR set must have the same number of channels.

Connections

	Cable	M12 Plug / Cable
Supply +	Brown	Pin 1 / Brown
Supply -	Blue	Pin 3 / Blue
SGT test input	Black	Pin 4 / Black
SGR output	Black	Pin 4 / Black
SGR output	Black	Pin 5 / Grey
SGR blanking function control	White	Pin 2 / White

5 pin, M12

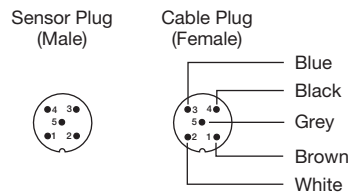

Refer to page 161 for extension cables

Wiring Diagrams

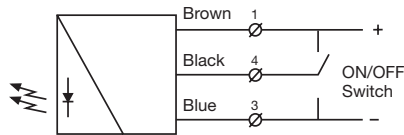

SGT 14
Connect black test input wire to + or - to disable SGT

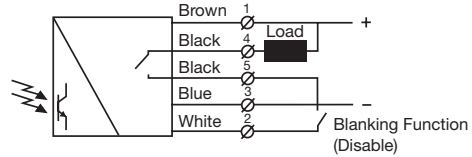

SGR 14 (load as NPN)

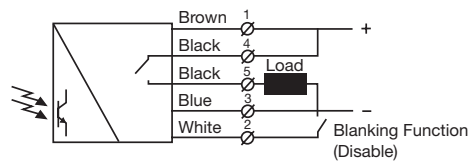

SGR 14 (load as PNP)

Dimensions and Descriptions

Slim Line C

Details

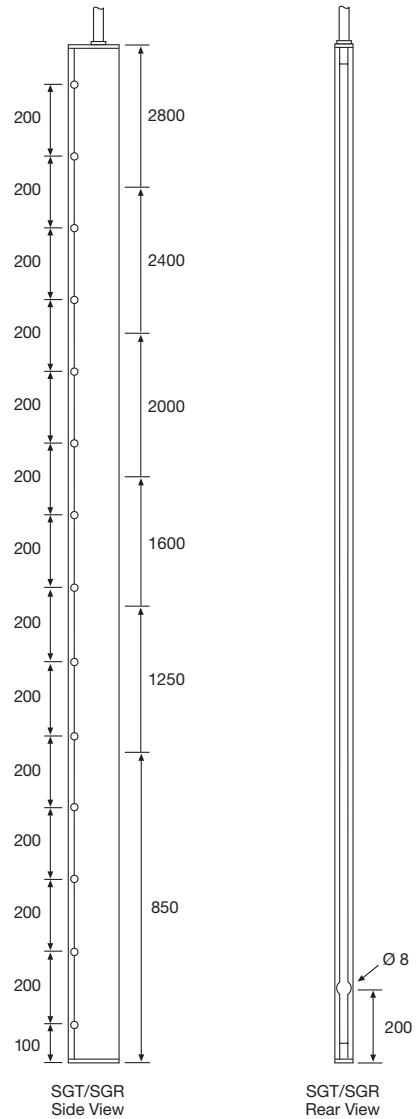
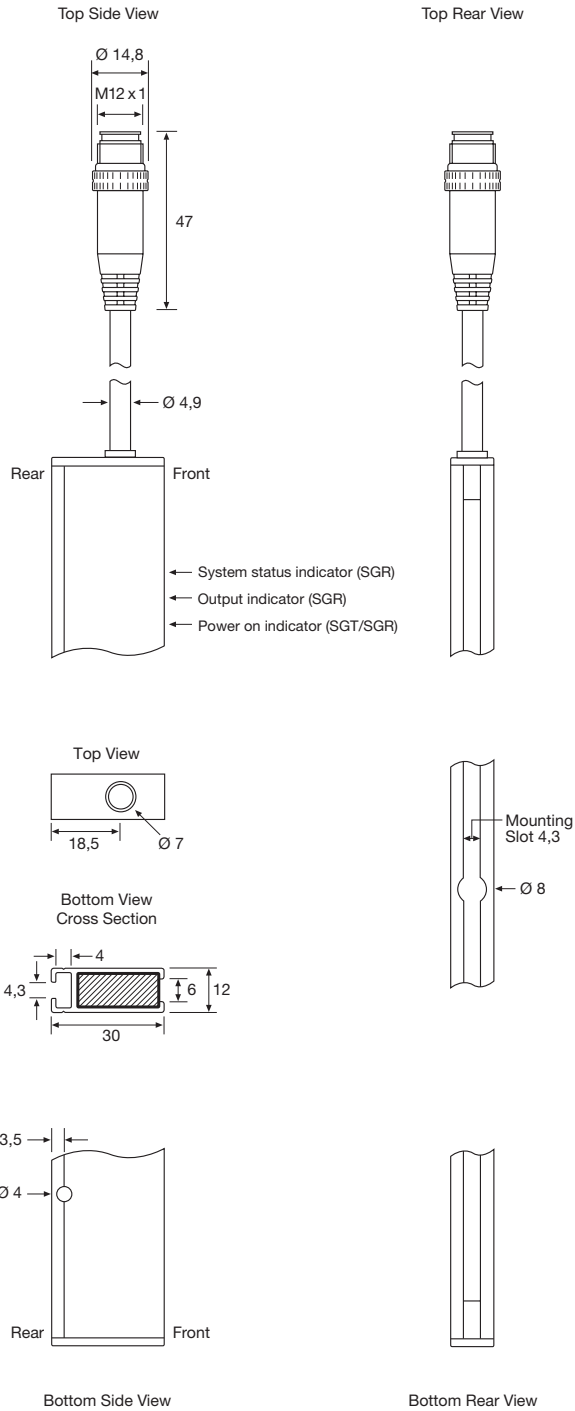

Note: Drawing shows model with M12 plug

(Units in mm)

Dimensions and Descriptions

Leading Edge D

Details

SGT
Top Front View

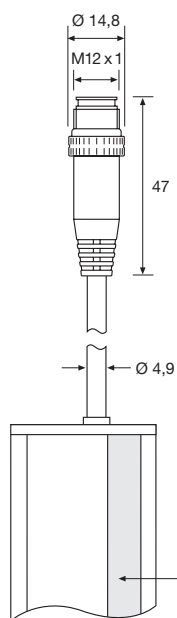

SGR
Top Front View

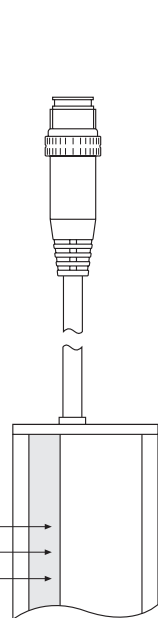

Top View

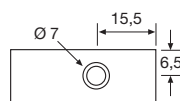

Top View

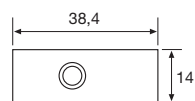

Bottom View
Cross Section

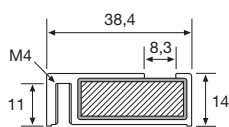

Bottom View
Cross Section

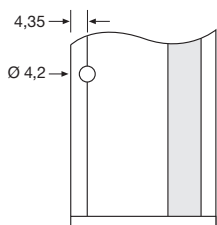
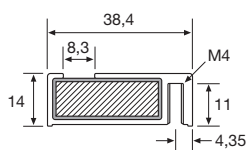

Bottom Front View

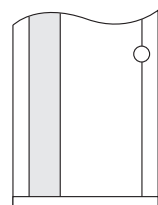

Bottom Front View

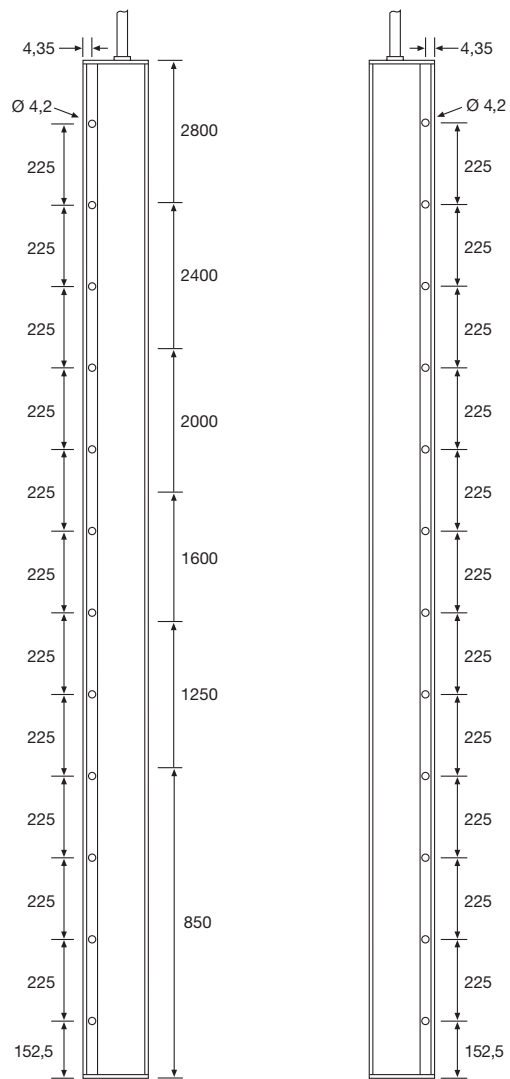

SGR
Rear View

SGT
Rear View

Note: Drawing shows model with M12 plug

(Units in mm)

Beam Patterns

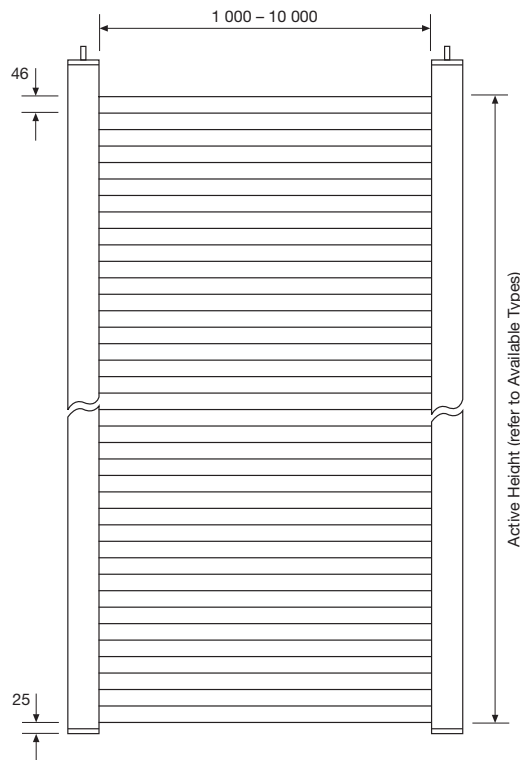

46 mm channel spacing

(Units in mm)

Sensing Characteristics

Parallel Displacement

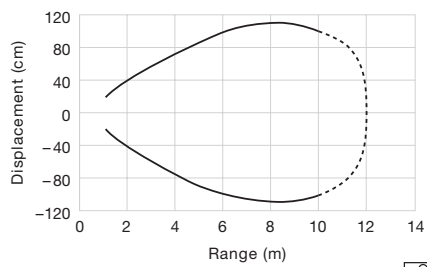

Slim Line C

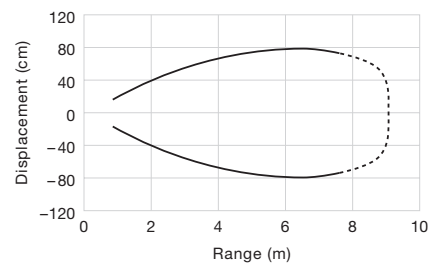
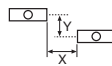

Leading Edge D



Telco reserves the right to change specifications without notice.

Description

- 115 V ac or 230 V ac supply voltage
- Relay output
- Nudging time-out relay output
- Switch selectable light or dark function
- Switch selectable receiver control function
- Switch selectable output reset function
- Switch selectable buzzer
- Adjustable nudging time-out delay
- Test push button
- Power, output and nudging output indicators
- Spring-clamp terminal connection



The SGC 1 is intended to be used in conjunction with the SG 1, SG 2, SG 10 or SG 14 self-contained light curtain series, where a DC supply voltage is not available and where an electromechanical relay output is required. The controller series is supplied with a fixed 24 V dc output voltage. Light or dark function and receiver control function is switch selectable.

The series is available with a nudging time-out feature which allows a

separate relay output to activate after a pre-set delay time after the signal output has been permanently activated. Nudging time-out delay is potentiometer adjustable from 3 to 60 seconds. The controller is available with a buzzer which may be activated to indicate a nudging time-out output.

The SGC 1 offers a test button, which may be used for disabling the transmitting power temporarily for test purposes.

Technical Data	
Supply voltage	115 V ac or 230 V ac
Voltage tolerance	+/- 10%
Current consumption	Max. 250 mA
Relay output	1 open / 1 close, 250 V ac / 3A, 120 V ac / 5A
Nudging relay output	1 open / 1 close, 250 V ac / 3A, 120 V ac / 5A
Supply output voltage	24 V dc
Supply output current	150 mA
Power on indicator	Green LED
Output indicator	Yellow LED
Nudging time-out indicator	Yellow LED
Housing material	ABS

Environmental Data	
Vibration	10-55 Hz, 1,5 mm
Shock	30 g
Temperature, operation	-20 to +65 °C
Temperature, storage	-40 to +80 °C
Sealing class	IP 54
Approvals	CE

Available Types					
Model	Connection	Output	Supply Voltage	115 V ac	230 V ac
			Feature	Order Reference	
SGC 1 A	Spring-clamp terminal	Relay	Nudging time-out function	SGC 1 A 501	SGC 1 A 500
SGC 1 B			-	SGC 1 B 501	SGC 1 B 500

Wiring Diagrams

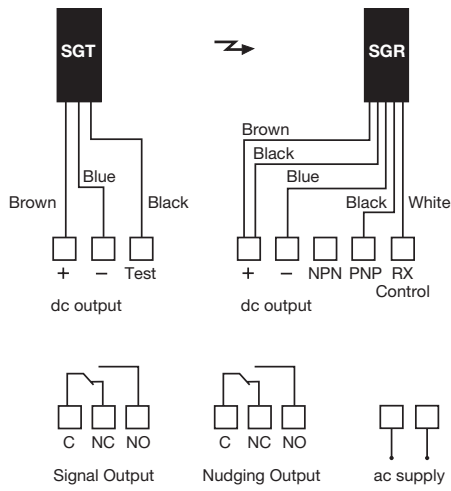

SGC 1 A
(Shown connected as PNP)

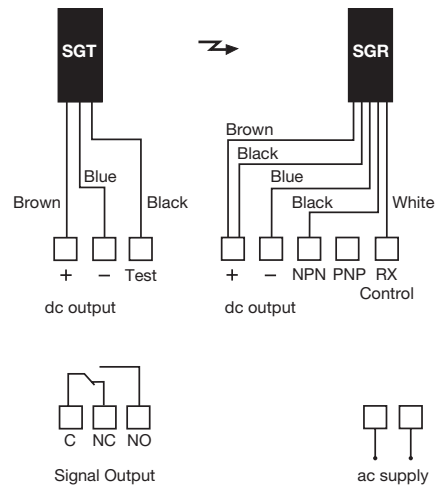

SGC 1 B
(Shown connected as NPN)

Dimensions and Descriptions

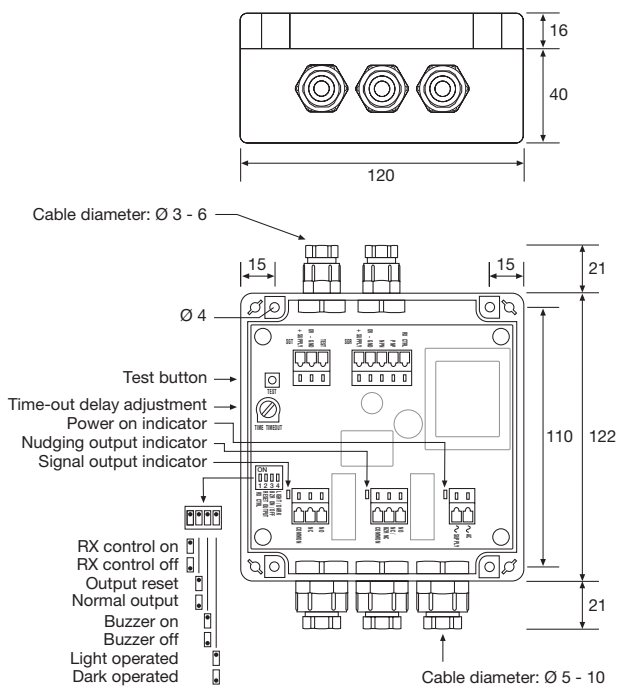

SGC 1 A

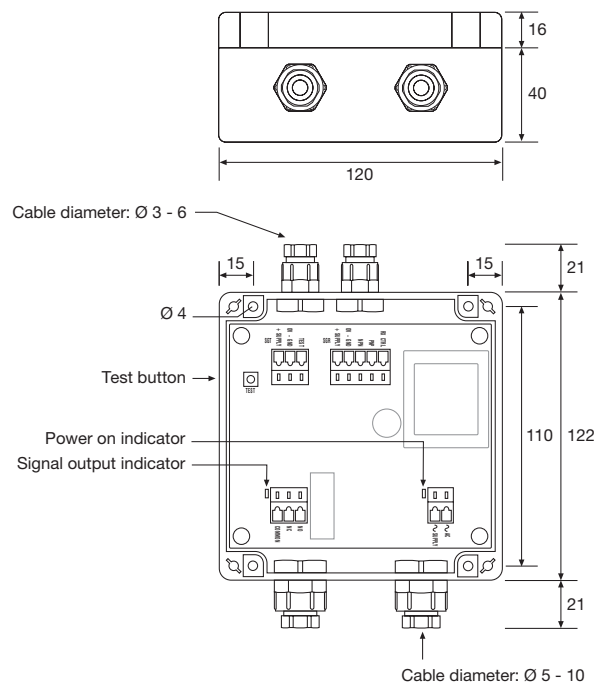

SGC 1 B

(Units in mm)

Telco reserves the right to change specifications without notice.

Description

- 5 m sensing range
- 16 to 64 parallel beams
- 28 or 56 mm beam spacing
- Active height of 425 mm to 1770 mm
- Detector length of 570 mm to 2105 mm
- Flexible cable
- Plug connection to controller
- Slim line (10x28 mm) or leading edge (37,5x13 mm) detector housing
- Power indicator
- Static and dynamic applications



The SpaceGuard SG 11 light curtain series, which consists of a transmitter detector, SGT and receiver detector, SGR, is made to operate in conjunction with a controller SGC 11. The detectors are housed in an aluminium profile available in a slim line design (10 x 28 mm) and a leading edge design (37,5 x 13 mm). The system can be used both in static and dynamic installations.

Technical Data

	28 mm channel spacing		56 mm channel spacing	
	SGT	SGR	SGT	SGR
Light source	Infrared (940 nm)	-	Infrared (940 nm)	-
Number of channels (diodes per detector)	16, 24, 32, 48, 56 or 64		16, 24 or 32	
Number of parallel beams	16, 24, 32, 48, 56 or 64		16, 24 or 32	
Active height	425, 650, 875, 1100, 1320, 1545 or 1770 mm		845, 1295 or 1740 mm	
Channel spacing	28 mm		56 mm	
Bottom spacing to Ch 1	22 mm			
Power on indicator	Red LED			
Housing dimensions (w x d)	Slim Line A	10 x 28 mm		
	Leading Edge B	37,5 x 13 mm		
Housing material	Profile	Aluminium (black anodised)		
	Lens cover	Acrylic (A housing) / Polycarbonate (B housing)		
Connection	5 pin, 240° DIN plug	5 pin, 180° DIN plug	5 pin, 240° DIN plug	5 pin, 180° DIN plug
Cable, PUR Ø 5,2 mm	5 x 0,14 mm ²			

Environmental Data

	SGT	SGR
Light immunity @ 20° incidence	-	> 10 000 lux
Temperature, operation	-20 to +55 °C	
Temperature, storage	-40 to +80 °C	
Sealing class	IP 54	
Approvals	CE	

Available Types

Slim Line A

Transmitter Detector	Housing Length	Active Height	Connection		4 m flexible cable	0.5 m flexible cable	Range
			No of Beams	Beam Spacing	Order Reference		
Transmitter Detector	570 mm	425 mm	16	28 mm	SGT 057-016-A1-A-4F	SGT 057-016-A1-A-0.5F	5 m
	795 mm	650 mm	24		SGT 080-024-A1-A-4F	SGT 080-024-A1-A-0.5F	
	1020 mm	845 mm	16	28 mm	SGT 102-016-B1-A-4F	SGT 102-016-B1-A-0.5F	
		875 mm	32		SGT 102-032-A1-A-4F	SGT 102-032-A1-A-0.5F	
	1245 mm	1100 mm	40	SGT 125-040-A1-A-4F	SGT 125-040-A1-A-0.5F		
	1470 mm	1295 mm	24	28 mm	SGT 147-024-B1-A-4F	SGT 147-024-B1-A-0.5F	
		1320 mm	48		SGT 147-048-A1-A-4F	SGT 147-048-A1-A-0.5F	
	1695 mm	1545 mm	56	SGT 170-056-A1-A-4F	SGT 170-056-A1-A-0.5F		
	1995 mm	1740 mm	32	28 mm	SGT 200-032-B1-A-4F	SGT 200-032-B1-A-0.5F	
		1770 mm	64		SGT 200-064-A1-A-4F	SGT 200-064-A1-A-0.5F	
	2105 mm	1740 mm	32	28 mm	SGT 210-032-B1-A-4F	SGT 210-032-B1-A-0.5F	
		1770 mm	64		SGT 210-064-A1-A-4F	SGT 210-064-A1-A-0.5F	

Receiver Detector	570 mm	425 mm	16	28 mm	SGR 057-016-A1-A-4F	SGR 057-016-A1-A-0.5F	5 m
	795 mm	650 mm	24		SGR 080-024-A1-A-4F	SGR 080-024-A1-A-0.5F	
	1020 mm	845 mm	16	28 mm	SGR 102-016-B1-A-4F	SGR 102-016-B1-A-0.5F	
		875 mm	32		SGR 102-032-A1-A-4F	SGR 102-032-A1-A-0.5F	
	1245 mm	1100 mm	40	SGR 125-040-A1-A-4F	SGR 125-040-A1-A-0.5F		
	1470 mm	1295 mm	24	28 mm	SGR 147-024-B1-A-4F	SGR 147-024-B1-A-0.5F	
		1320 mm	48		SGR 147-048-A1-A-4F	SGR 147-048-A1-A-0.5F	
	1695 mm	1545 mm	56	SGR 170-056-A1-A-4F	SGR 170-056-A1-A-0.5F		
	1995 mm	1740 mm	32	28 mm	SGR 200-032-B1-A-4F	SGR 200-032-B1-A-0.5F	
		1770 mm	64		SGR 200-064-A1-A-4F	SGR 200-064-A1-A-0.5F	
	2105 mm	1740 mm	32	28 mm	SGR 210-032-B1-A-4F	SGR 210-032-B1-A-0.5F	
		1770 mm	64		SGR 210-064-A1-A-4F	SGR 210-064-A1-A-0.5F	

Leading Edge B

Transmitter Detector	570 mm	425 mm	16	28 mm	SGT 057-016-A1-B-4F	SGT 057-016-A1-B-0.5F	3.5 m
	795 mm	650 mm	24		SGT 080-024-A1-B-4F	SGT 080-024-A1-B-0.5F	
	1020 mm	845 mm	16	28 mm	SGT 102-016-B1-B-4F	SGT 102-016-B1-B-0.5F	
		875 mm	32		SGT 102-032-A1-B-4F	SGT 102-032-A1-B-0.5F	
	1245 mm	1100 mm	40	SGT 125-040-A1-B-4F	SGT 125-040-A1-B-0.5F		
	1470 mm	1295 mm	24	28 mm	SGT 147-024-B1-B-4F	SGT 147-024-B1-B-0.5F	
		1320 mm	48		SGT 147-048-A1-B-4F	SGT 147-048-A1-B-0.5F	
	1695 mm	1545 mm	56	SGT 170-056-A1-B-4F	SGT 170-056-A1-B-0.5F		
	1995 mm	1740 mm	32	28 mm	SGT 200-032-B1-B-4F	SGT 200-032-B1-B-0.5F	
		1770 mm	64		SGT 200-064-A1-B-4F	SGT 200-064-A1-B-0.5F	
	2105 mm	1740 mm	32	28 mm	SGT 210-032-B1-B-4F	SGT 210-032-B1-B-0.5F	
		1770 mm	64		SGT 210-064-A1-B-4F	SGT 210-064-A1-B-0.5F	

Receiver Detector	570 mm	425 mm	16	28 mm	SGR 057-016-A1-B-4F	SGR 057-016-A1-B-0.5F	3.5 m
	795 mm	650 mm	24		SGR 080-024-A1-B-4F	SGR 080-024-A1-B-0.5F	
	1020 mm	845 mm	16	28 mm	SGR 102-016-B1-B-4F	SGR 102-016-B1-B-0.5F	
		875 mm	32		SGR 102-032-A1-B-4F	SGR 102-032-A1-B-0.5F	
	1245 mm	1100 mm	40	SGR 125-040-A1-B-4F	SGR 125-040-A1-B-0.5F		
	1470 mm	1295 mm	24	28 mm	SGR 147-024-B1-B-4F	SGR 147-024-B1-B-0.5F	
		1320 mm	48		SGR 147-048-A1-B-4F	SGR 147-048-A1-B-0.5F	
	1695 mm	1545 mm	56	SGR 170-056-A1-B-4F	SGR 170-056-A1-B-0.5F		
	1995 mm	1740 mm	32	28 mm	SGR 200-032-B1-B-4F	SGR 200-032-B1-B-0.5F	
		1770 mm	64		SGR 200-064-A1-B-4F	SGR 200-064-A1-B-0.5F	
	2105 mm	1740 mm	32	28 mm	SGR 210-032-B1-B-4F	SGR 210-032-B1-B-0.5F	
		1770 mm	64		SGR 210-064-A1-B-4F	SGR 210-064-A1-B-0.5F	

- Note: 1. The transmitter SGT and the receiver SGR set must always have the same number of light beams and the same beam spacing
 2. Special lengths are available upon request
 3. Special epoxy moulding for IP 65 rating available upon request

Dimensions and Descriptions

Leading Edge B

Details

SGT
Top Front View
(shown with screw cover strip)

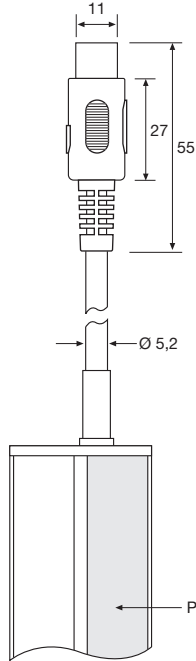

SGR
Top Front View
(shown without screw cover strip)

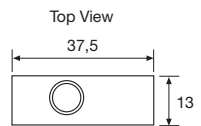
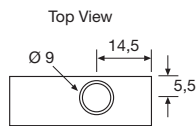
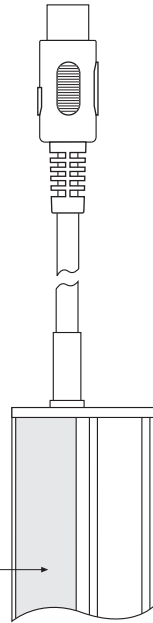

Bottom View
Cross Section

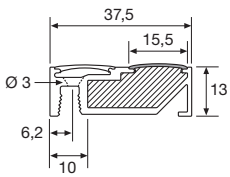

Bottom View
Cross Section

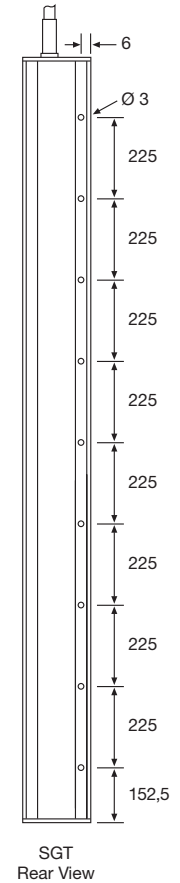
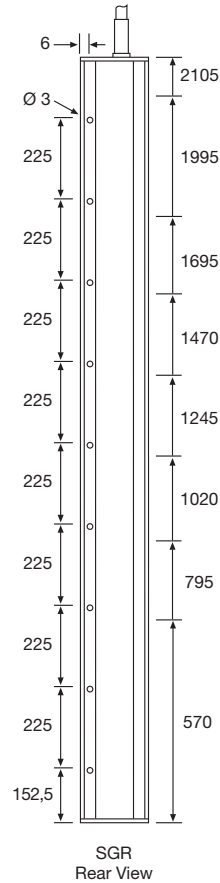
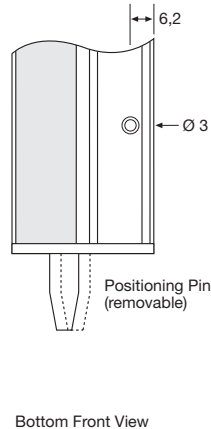
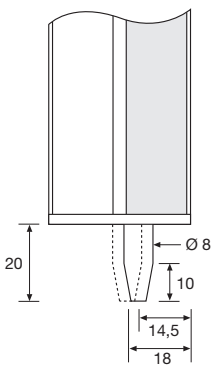
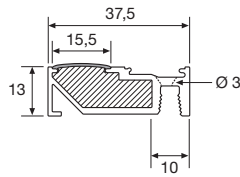

SGT/SGR 057 to 210

(Units in mm)

Beam Patterns

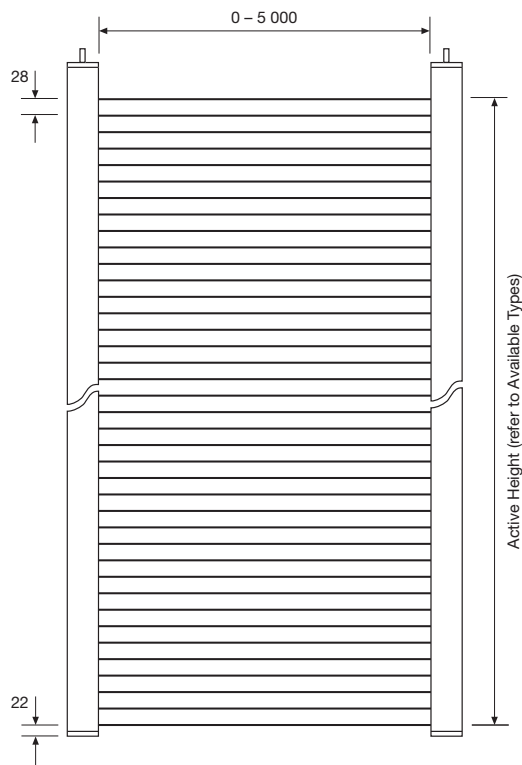

28 mm channel spacing

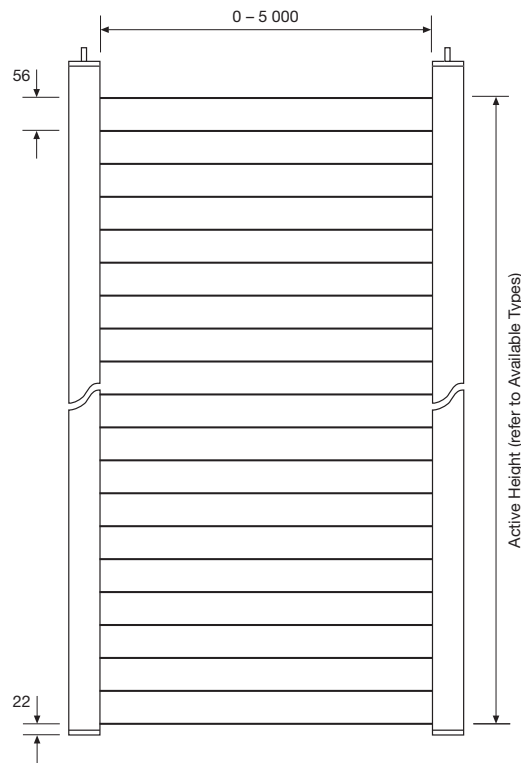

56 mm channel spacing

(Units in mm)

Sensing Characteristics

Parallel Displacement

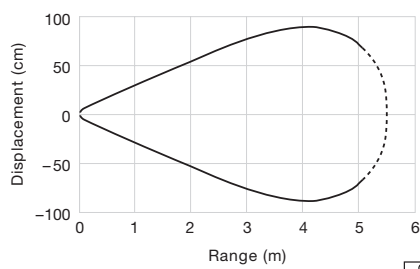

Slim Line A

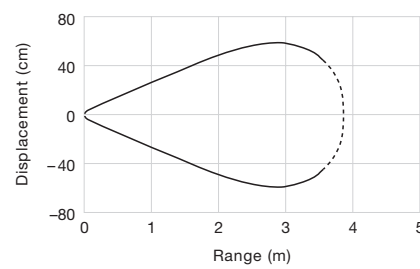
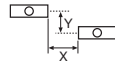

Leading Edge B



Extension Cables

Dimension Drawing	Cable Type	Installation	Sealing Class	Length	Connector	Transmitter	Receiver
						5 pin, 240° DIN plug	5 pin, 180° DIN plug
					Material	Order Reference	
	Flexible	Dynamic and Static	IP 67	4 m	PUR	CBG 5 S 4	CBH 5 S 4

Telco reserves the right to change specifications without notice.

Description

- 0-5 m sensing range
- 230 V ac, 115 V ac or 24 V ac – all with 24 V dc supply voltage
- Manual and automatic sensitivity adjustment
- Automatic detector test
- 1 relay and/or 1 transistor output
- Switch selectable light or dark function
- Switch selectable long or short range
- Switch selectable buzzer
- Selectable time-out function
- Power, output, alarm, time-out and detector failure indicators
- Alarm and time-out output
- Plug connection to detectors



The SGC 11 is to be used in conjunction with a set of light curtain transmitter detector SGT and receiver detector SGR, from the SG 11 series.

The series offers automatic and manual sensitivity adjustment via an integral potentiometer. Output can be selected from either a relay or NPN transistor output. Light or dark function and long or short range is switch selectable. The time-out function is switch selectable for 4 to 32 channels, which allows the selected number of channels to be automatically ignored if permanently obstructed for a pre-set period of time, switch selectable from 0.3 to 10 minutes.

The microprocessor controlled detector test ensures that the system will automatically detect and indicate a faulty transmitter or receiver detector, cable break or electrical failure – during operation. The output relay will revert to safe position and the failure will be indicated by the detector failure indicators or alarm indicator. The controller is available with a time-out and alarm NPN transistor output.

The time-out output is activated when one or more channels are timed out, and the alarm output is activated when more than 75% of the channels are timed-out or when the controller detects a system fault.

The controller features a buzzer, which may be activated to indicate a signal output and/or an alarm.

Technical Data		
Supply voltage	ac	24 V ac, 115 V ac or 230 V ac
	dc	24 V dc
Voltage tolerance	ac	-12 % / +6 %
	dc	+/- 15 %
Current consumption		Max. 15 VA
Output	Relay	1 open / 1 close, 250 V ac / 3 A, 120 V ac / 5 A
	Transistor NPN	Max 24 V dc / 100 mA
Power on indicator		Green LED
Output indicator		Yellow LED
Alarm indicator		Red LED
Time-out indicator		Red LED
SGT detector failure indicator		Red LED
SGR detector failure indicator		Red LED
Time-out function		4 to 32 channels, selectable
Max. response time	Relay	(Number of channels x 2 ms) + 10 ms
	Transistor NPN	(Number of channels x 2 ms) + 2 ms
Housing material		Polycarbonate

Environmental Data	
Vibration	10-55 Hz, 1,5 mm
Shock	30 g
Temperature, operation	-10 to +40 °C
Temperature, storage	-40 to +80 °C
Sealing class	IP 20
Approvals	CE 

Available Types

Model	Connection	Output	Supply Voltage	24 V ac / 24 V dc	115 V ac / 24 V dc	230 V ac / 24 V dc
			Feature	Order Reference		
SGC 11 A	Spring-clamp and DIN terminals	Relay and NPN	Alarm and time out outputs	SGC 11 A 302	SGC 11 A 301	SGC 11 A 300
		Relay	-	SGC 11 A 502	SGC 11 A 501	SGC 11 A 500

Note: Detectors to be ordered separately.

Wiring Diagrams

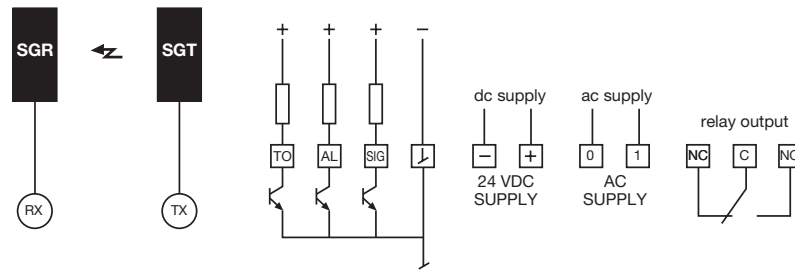

SGC 11 A 30x (Relay and NPN output)

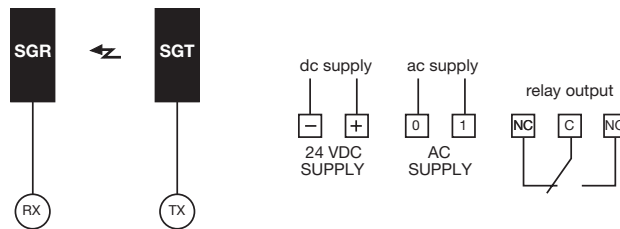

SGC 11 A 50x (Relay output)

Dimensions and Descriptions

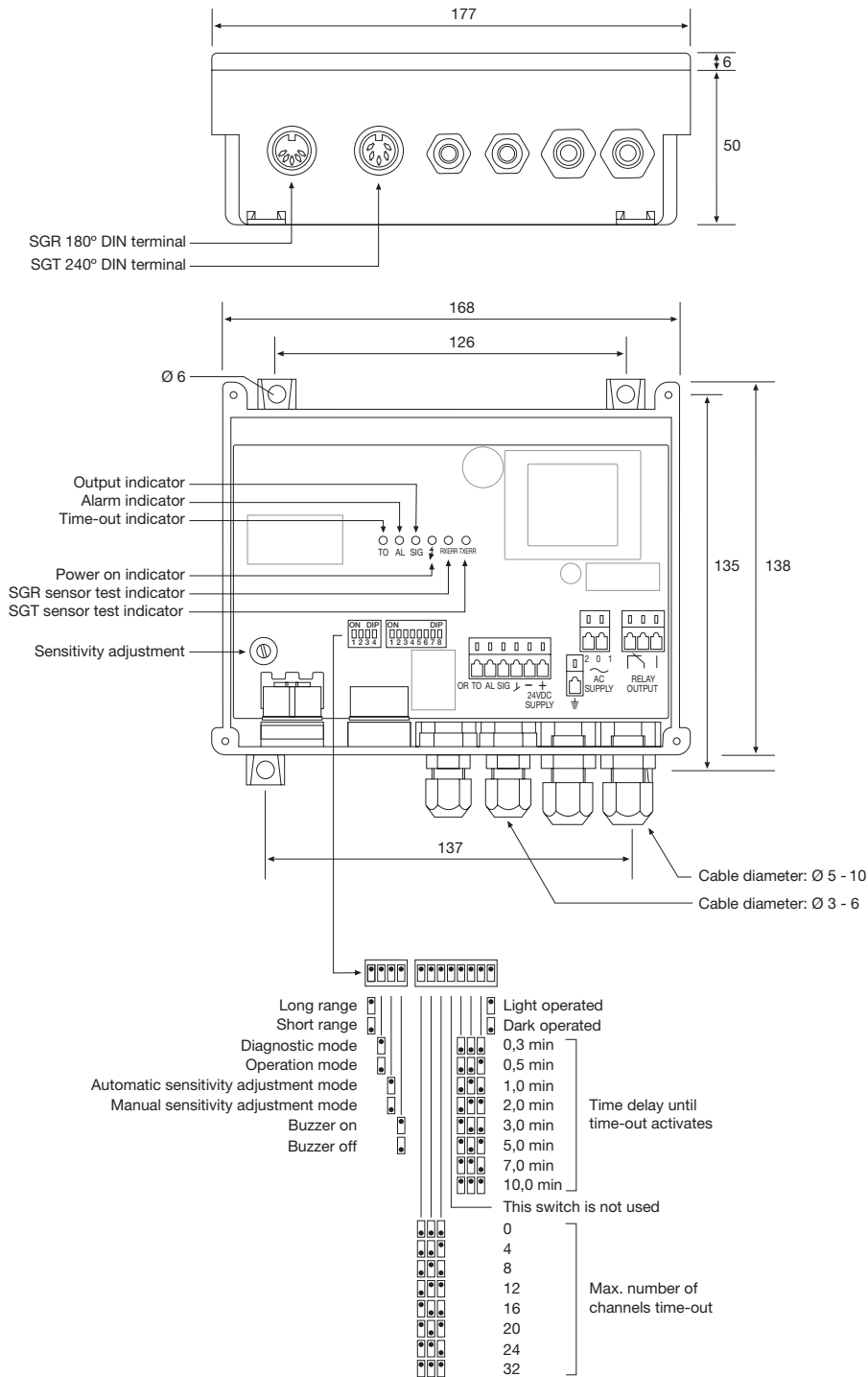

(Units in mm)

Telco reserves the right to change specifications without notice.

OPTICAL FORK SENSOR SERIES



Description

- 2 mm to 220 mm fork width
- Aluminium housing
- Plug connection
- Infrared or visible red light source
- High power version available
- Sensitivity adjustment via potentiometer
- Switch selectable light or dark function
- Output indicator
- High tolerance to hostile environments
- 10-35 V dc supply voltage
- 3 wire, NPN or PNP output
- High switching frequency

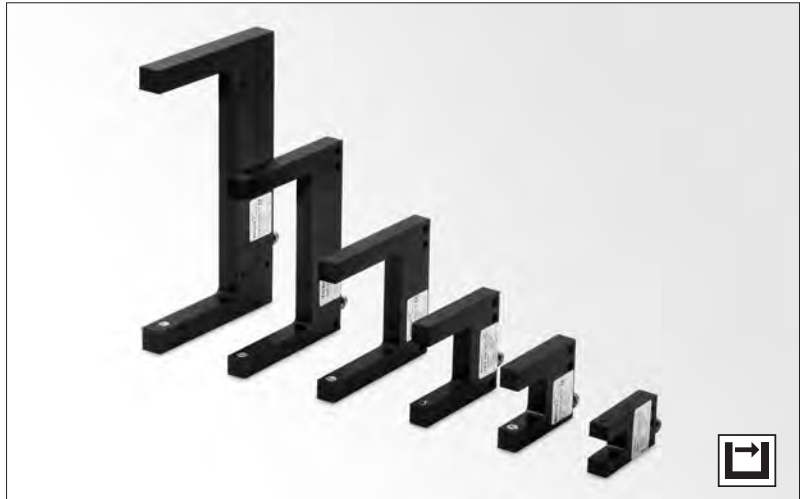

The OFS series consists of self-contained optical fork sensors that are housed in a durable, U-shaped aluminium housing which operates in thru-beam mode, available with infrared (OFS), visible red (OFSR) or high power infrared (OFSH) light source. The series is available with a wide variety of fork opening widths, ranging from 2 mm to 220 mm.

The complete series is available as a 3 wire, NPN or PNP transistor

output with a 10-35 V dc supply voltage. All models offer sensitivity adjustment via integral potentiometer and are available with switch selectable light or dark function. The complete series offers a high switching frequency of up to 5000 Hz.

The series is protected against reverse polarity of power supplies and output signals. The output is protected against short circuit and inductive loads.

Technical Data

		002	005	010	020	030	050	080	120	220	
Supply voltage		10-35 V dc									
Reverse polarity protected		Yes									
Short circuit protected		Yes									
Current consumption		Max. 35 mA									
Maximum output load		200 mA									
Resolution		0,4 mm									
OFS					0,4 mm						
OFSR		-			1,5 mm				-		
OFSH		-							-		
Operation frequency		2500 Hz			5000 Hz			2500 Hz			
OFSR		-			5000 Hz			2500 Hz			
OFSH		-			5000 Hz			-			
Response time		0,2 ms / 0,2 ms			0,1 ms / 0,1 ms			0,2 ms / 0,2 ms			
OFSR		-			0,1 ms / 0,1 ms			0,2 ms / 0,2 ms			
OFSH		-			0,1 ms / 0,1 ms			-			
Output indicator		Yellow LED									
Hysteresis		< 0,2 mm									
Light source		Infrared (880 nm)									
OFS		Infrared (880 nm)									
OFSR		-			Visible red (660 nm)						-
OFSH		-			High power infrared (880 nm)						-
Fork opening width		2 mm	5 mm	10 mm	20 mm	30 mm	50 mm	80 mm	120 mm	220 mm	
Housing material		Aluminium (black anodised)									
Fork housing		Aluminium (black anodised)									
Lens cover		Glass									

Environmental Data

Vibration	10-55 Hz, 0,5 mm
Shock	30 g
Light immunity, @ 15° incidence	> 50 000 lux
Temperature, operation	-20 to +60 °C
Temperature, storage	-40 to +80 °C
Sealing class	IP 67
Approvals	CE

Available Types

Type	Fork Opening Size		Control Feature	Light Source		Infrared	Visible Red	Infrared (high power)
	Width	Depth		Output				
OFS 002	2 mm	40 mm	Sensitivity pot. and light/dark switch	NPN	DO/LO (NO/NC)	OFS 002 N3S T3	-	-
				PNP	DO/LO (NO/NC)	OFS 002 P3S T3	-	-
OFS 005	5 mm	17 mm	Sensitivity pot.	NPN	LO (NC)	OFS 005 N1S T3	-	-
					DO (NO)	OFS 005 N2S T3	-	-
				PNP	LO (NC)	OFS 005 P1S T3	-	-
					DO (NO)	OFS 005 P2S T3	-	-
OFS 010	10 mm	17 mm	Sensitivity pot.	NPN	LO (NC)	OFS 010 N1S T3	-	-
					DO (NO)	OFS 010 N2S T3	-	-
				PNP	LO (NC)	OFS 010 P1S T3	-	-
					DO (NO)	OFS 010 P2S T3	-	-
OFS 020	20 mm	25 mm	Sensitivity pot.	NPN	LO (NC)	OFS 020 N1S T3	OFSR 020 N1S T3	OFSH 020 N1S T3
					DO (NO)	OFS 020 N2S T3	OFSR 020 N2S T3	OFSH 020 N2S T3
				PNP	LO (NC)	OFS 020 P1S T3	OFSR 020 P1S T3	OFSH 020 P1S T3
					DO (NO)	OFS 020 P2S T3	OFSR 020 P2S T3	OFSH 020 P2S T3
OFS 030	30 mm	35 mm	Sensitivity pot. and light/dark switch	NPN	DO/LO (NO/NC)	OFS 030 N3S T3	OFSR 030 N3S T3	OFSH 030 N3S T3
				PNP	DO/LO (NO/NC)	OFS 030 P3S T3	OFSR 030 P3S T3	OFSH 030 P3S T3
OFS 050	50 mm	55 mm	Sensitivity pot. and light/dark switch	NPN	DO/LO (NO/NC)	OFS 050 N3S T3	OFSR 050 N3S T3	OFSH 050 N3S T3
				PNP	DO/LO (NO/NC)	OFS 050 P3S T3	OFSR 050 P3S T3	OFSH 050 P3S T3
OFS 080	80 mm	55 mm	Sensitivity pot. and light/dark switch	NPN	DO/LO (NO/NC)	OFS 080 N3S T3	OFSR 080 N3S T3	OFSH 080 N3S T3
				PNP	DO/LO (NO/NC)	OFS 080 P3S T3	OFSR 080 P3S T3	OFSH 080 P3S T3
OFS 120	120 mm	60 mm	Sensitivity pot. and light/dark switch	NPN	DO/LO (NO/NC)	OFS 120 N3S T3	OFSR 120 N3S T3	-
				PNP	DO/LO (NO/NC)	OFS 120 P3S T3	OFSR 120 P3S T3	-
		205 mm		NPN	DO/LO (NO/NC)	OFS 120-205 N3S T3	OFSR 120-205 N3S T3	-
				PNP	DO/LO (NO/NC)	OFS 120-205 P3S T3	OFSR 120-205 P3S T3	-
OFS 220	220 mm	110 mm	Sensitivity pot. and light/dark switch	NPN	DO/LO (NO/NC)	OFS 220 N3S T3	OFSR 220 N3S T3	-
				PNP	DO/LO (NO/NC)	OFS 220 P3S T3	OFSR 220 P3S T3	-

Note: Different size models are available upon request.

Connections

	M8 Plug / Cable
Supply +	Pin 1 / Brown
Supply -	Pin 3 / Blue
Output	Pin 4 / Black

3 pin, M8

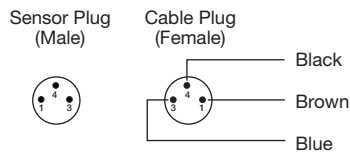

Wiring Diagrams

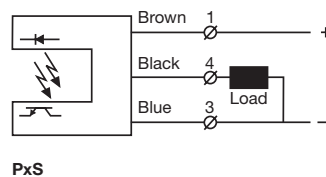
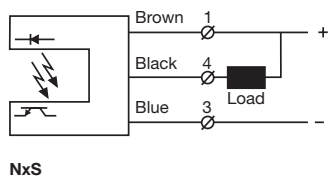

Dimensions and Descriptions

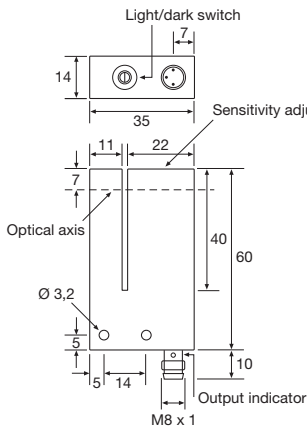

OFS 002

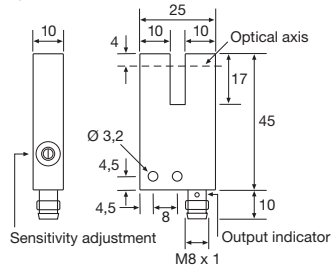

OFS 005

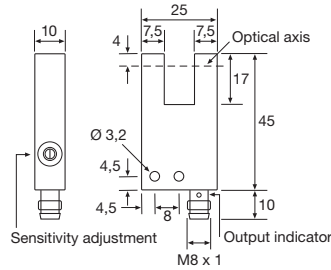

OFS 010

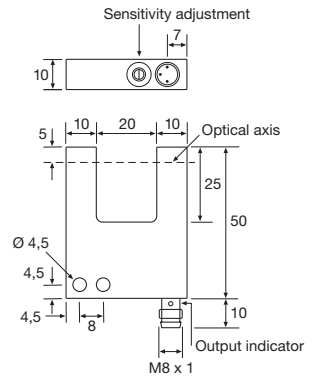

OFS 020

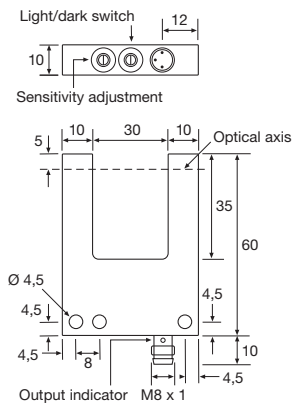

OFS 030

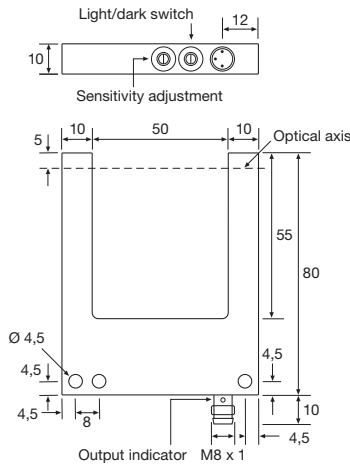

OFS 050

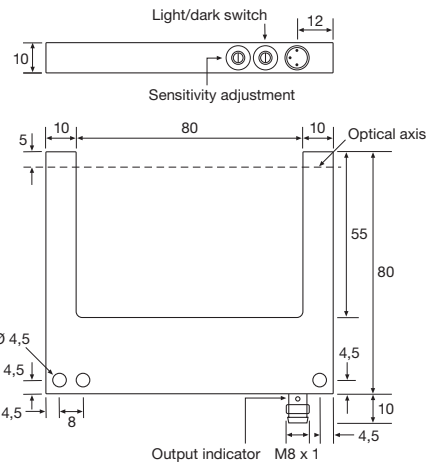

OFS 080

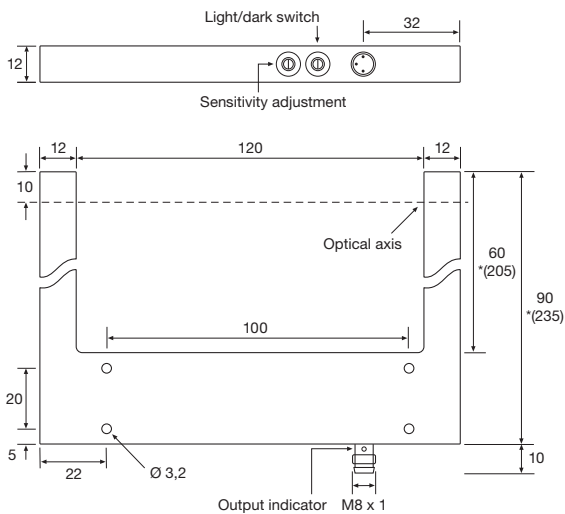

OFS 120
*(OFS 120-205)

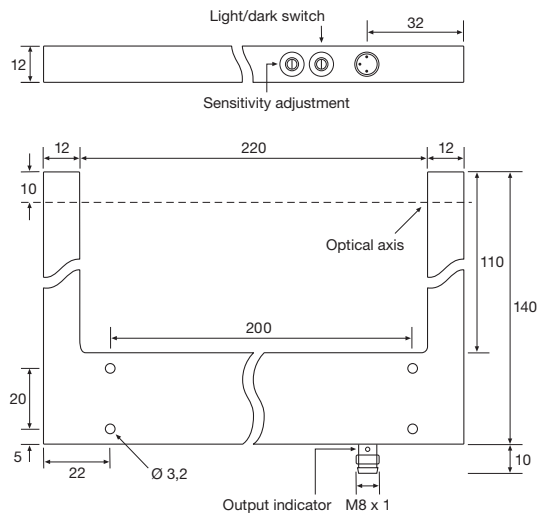

OFS 220

(Units in mm)

Telco reserves the right to change specifications without notice.

ACCESSORIES

Description

- 115 V ac or 230 V ac supply voltage
- 1 relay output
- Adjustable on/off time delay
- Switch selectable light or dark function
- Power, input and output indicators
- 11-pole DIN socket connection



The PP 00 is intended to be used in conjunction with a Spacemaster, SpacePak or SpaceGuard system, where a DC supply voltage is not available and where a relay output is required. This power pack series provides a fixed 15 V dc output voltage, available with or without an adjustable 0-10 sec on/off time delay. Light or dark function is switch selectable.

Technical Data	
Supply voltage	115 V ac or 230 V ac
Voltage tolerance	+/- 15%
Current consumption	Max. 4 VA
Relay output	1 open / 1 close 250 V ac / 3A, 120 V ac / 5A
Output voltage	15 V
Output current	Max. 175 mA
Power on indicator	Green LED
Input indicator	Green LED
Output indicator	Yellow LED
Delay t _{ON} / t _{OFF}	PP 00 A 0-10 sec, adjustable
Housing material	Noryl

Environmental Data	
Temperature, operation	-10 to +50 °C
Temperature, storage	-40 to +80 °C
Sealing class	IP 40
Approvals	CE eTUVus

Available Types					
Model	Connection	Time Delay	Supply Voltage		Order Reference
			115 V ac	230 V ac	
PP 00 A	11-pole DIN socket	On/Off delay	Relay	PP 00 A 501	PP 00 A 500
PP 00 B		-		PP 00 B 501	PP 00 B 500

Note: 11-pole DIN socket to be ordered separately.

Wiring Diagrams

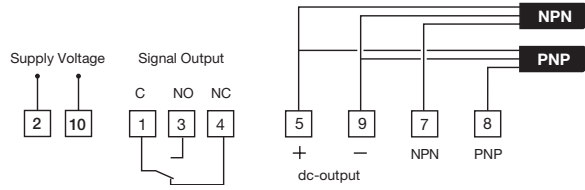

Dimensions and Descriptions

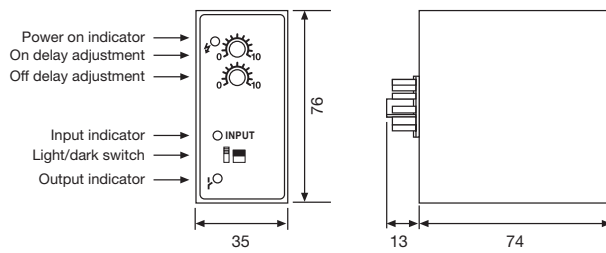

PP 00 A

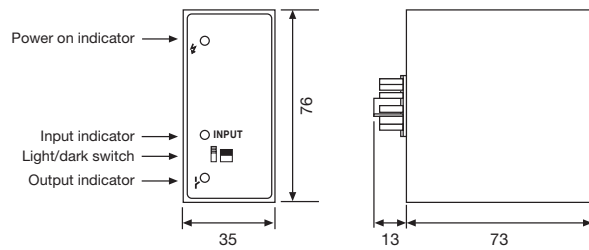

PP 00 B

(Units in mm)

Telco reserves the right to change specifications without notice.

GLASS FIBRE OPTICS

Description

- Ideal for use in explosive areas
- Insensitive to electromagnetic and capacitive influence
- High temperature operation
- Various adaptor types
- Wide variety of sensing tip designs
- Bifurcated or individual fibre construction
- Silicone or stainless steel sleeves



Technical Data

Cover	Silicone / Stainless Steel (AISI 304 / 1.4301)	
Sheath material	Stainless Steel (AISI 304 / 1.4301)	
Sealing	IP 67	
Strand diameter	50 µm	
Bundle diameter	1,0; 2,3; 3,5; 4,0; 4,5 mm	
Opening angle	67°	
Adaptor Material	Stainless Steel (AISI 304 / 1.4301)	
Bending Radius	> 5 x cover diameter	
Temperature, Operation	Silicone	-40 to +180 °C
	Stainless Steel	-40 to +300 °C

Available types for SMPF 7000 and 8000 Series

Sensing End Tip Dimensions	Active Ø	Adaptor Type	Sensing Mode	Range	Sleeve Material	Silicone	Stainless Steel
					Cable Length	Order Reference	
	1,0 mm	C	Thru Beam	10 cm	0,6 m	LLS 1300	LLM 1300
		D	Diffuse Proximity	0,4 cm		LYS 1301	LYM 1301
	1,0 mm	D	Diffuse Proximity	0,4 cm		LYS 1323	LYM 1323
		C	Thru Beam	60 cm		LLS 1304	LLM 1304
	2,3 mm	D	Diffuse Proximity	2,5 cm		LYS 1305	LYM 1305
		C	Thru Beam	60 cm		LLS 1302	LLM 1302
	2,3 mm	D	Diffuse Proximity	2,5 cm		LYS 1303	LYM 1303
		C	Thru Beam	75 cm		LLS 1310	LLM 1310
	3,5 mm	D	Diffuse Proximity	6 cm		LYS 1307	LYM 1307
		C	Thru Beam	9 cm		LLS 1312	LLM 1312
	1,0 mm	D	Diffuse Proximity	0,3 cm	LYS 1313	LYM 1313	
		C	Thru Beam	55 cm	LLS 1314	LLM 1314	
	2,3 mm	D	Diffuse Proximity	2,5 cm	LYS 1315	LYM 1315	
		C	Thru Beam	45 cm	LLS 1318	LLM 1318	
	2,3 mm	D	Diffuse Proximity	2,5 cm	LYS 1317	LYM 1317	
		C	Thru Beam	50 cm	LLS 1362	LLM 1362	
	0,3 x 20 mm	D	Diffuse Proximity	2 cm	LYS 1371	LYM 1371	
		C	Thru Beam	20 cm	LLS 1370	LLM 1370	
		C	Thru Beam	20 cm	1,5 m	LLS 1370	LLM 1370
Aluminium							
Adaptor Type C – Individual Fibre Construction				Adaptor Type D – Bifurcated Fibre Construction			
(Units in mm)							

GLASS FIBRE OPTICS

Available types for Remote Photoelectric Systems

Sensing End Tip Dimensions	Active Ø	Adaptor Type	Sensing Mode	Range	Sleeve Material		
					Silicone	Stainless Steel	
					Cable Length	Order Reference	
	4,0 mm	A	Thru Beam	8 m	0,5 m	LLS 1306	LLM 1306
				6 m	1,5 m	LLS 1326	LLM 1326
				7 m	1,0 m	LLS 1308	LLM 1308
	4,5 mm	B	Diffuse Proximity	0,7 m	0,5 m	LYS 1309	LYM 1309
				0,6 m	1,0 m	LYS 1311	LYM 1311
	2,3 mm	A	Thru Beam	2,5 m	1,5 m	LLS 1316	LLM 1316
	0,3 x 20 mm			1,4 m	0,6 m	LLS 1374	LLM 1374
				1,25 m	1,0 m	LLS 1368	LLM 1368
Adaptor Type A – Individual Fibre Construction				Adaptor Type B – Bifurcated Fibre Construction			
(Units in mm)							

Note: Range specified using PA 11 amplifier (page 28) in combination with Remote Sensor Series 100 (page 15).

Telco reserves the right to change specifications without notice.

MOUNTING BRACKETS

TR 10S

Screw clamp.
Size: Ø 10.
Material: Polycarbonate.

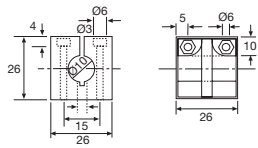

TR 10-28P

Surface mounting bracket.
Size: Ø 10.
Material: Polycarbonate.

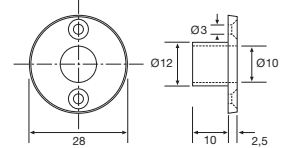

TR 10KB

Mounting clip.
Size: Ø 10.
Material: Polycarbonate.

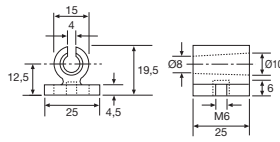

TR 6M

Screw clamp.
Size: Ø 6.
Material: Brass.

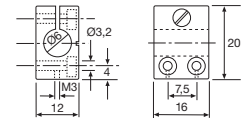

TR 10KG

Mounting Bracket
(40° swivel).
Size: Ø 10.
Material: Polycarbonate.

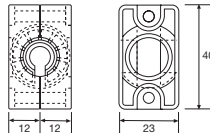

TR 8M

Screw clamp.
Size: Ø 8.
Material: Brass.

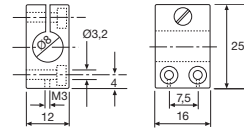

TR 10SB

Snap bushing.
Size: Ø 10.
Material: Polycarbonate.

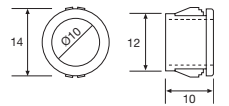

TR 10M

Screw clamp.
Size: Ø 10.
Material: Brass.

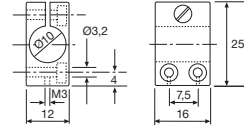

TR 10PG

Mounting nut.
Size: Ø 10.
Material: Polycarbonate.

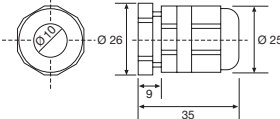

TR 12M

Screw clamp.
Size: Ø 12.
Material: Brass.

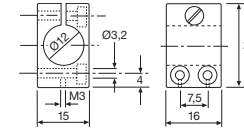

TRN 8

Mounting Bracket.
Size: Ø 8.
Material: Polycarbonate.

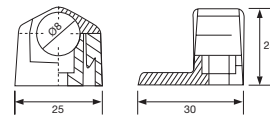

TR SP35-50 L

Mounting Bracket.
Size: 50 x 50.
Material: Stainless Steel.
2 x M4 hardware included.

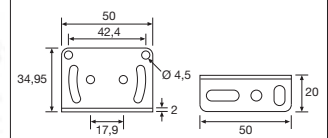

(Units in mm)

TRN 10

Mounting Bracket.
Size: Ø 10.
Material: Polycarbonate.

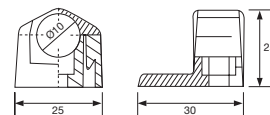

TRN 12

Mounting Bracket.
Size: Ø 12.
Material: Polycarbonate.

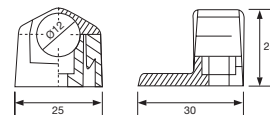





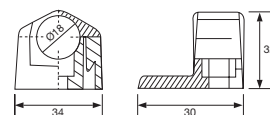





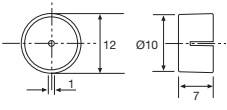

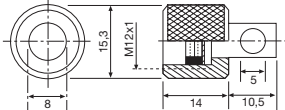

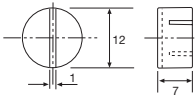

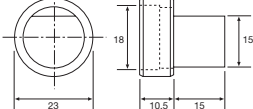

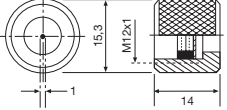

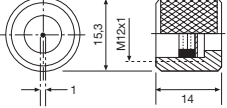

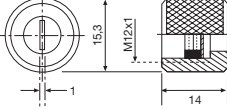
TRN 18

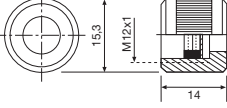
Mounting Bracket.
Size: Ø 18.
Material: Polycarbonate.

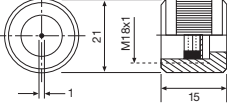

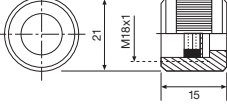
Telco reserves the right to change specifications without notice.

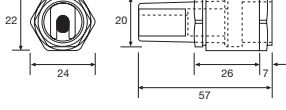
APERTURES

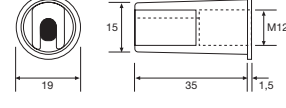
<p>TRE Light shutter with 1 mm hole. Size: Ø 10. Material: Aluminium.</p>			<p>TRWM 90 90° angle adaptor. Size: M12. Material: Stainless Steel.</p>		
<p>TRD Light shutter with 1 mm slit. Size: Ø 10. Material: Aluminium.</p>			<p>FA 18 SO 90° angle adaptor. Size: M18. Material: Polycarbonate.</p>		
(Units in mm)					
<p>TREM 12 Light shutter with 1 mm hole. Size: M12. Material: Stainless Steel.</p>					
<p>TREGM 12 Light shutter with 1 mm hole with protective glass cover. Size: M12. Material: Stainless Steel.</p>					
<p>TRDGM 12 Light shutter with 1 mm slot with protective glass cover. Size: M12. Material: Stainless Steel.</p>					
<p>TRGM 12 Protective glass cover. Size: M12. Material: Stainless Steel.</p>					
<p>TREGM 18 Light shutter with 1 mm hole with protective glass cover. Size: M18. Material: Stainless Steel.</p>					
<p>TRGM 18 Protective glass cover. Size: M18. Material: Stainless Steel.</p>					
<p>TRPG 11 Light shutter (tubus). Size: Ø 10. Material: Stainless Steel/Polycarbonate.</p>					
<p>TU 12 Light shutter (tubus). Size: M12. Material: Polycarbonate.</p>					

Telco reserves the right to change specifications without notice.

REFLECTORS

Rectangular Reflectors

ILR 31-46 R

Size: 46 mm x 31 mm.
Material: PMMA.
Temperature: -40 to +70 °C.
Sealing Class: IP 67.

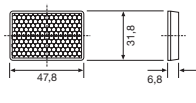

ILR 30-60 RHF

Size: 81 mm x 30 mm.
Material: PMMA.
Temperature: -40 to +70 °C.
Sealing Class: IP 67.

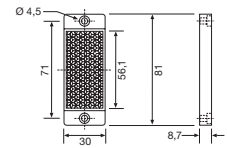

ILR 19-53 RHF

Size: 19 mm x 73 mm.
Material: PMMA.
Temperature: -40 to +70 °C.
Sealing Class: IP 67.

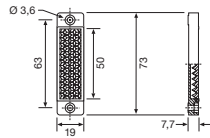

ILR 41-60 RS

Size: 41 mm x 60 mm.
Material: PMMA.
Temperature: -40 to +70 °C.
Sealing Class: IP 67.

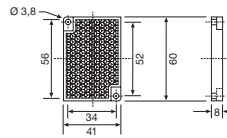

ILR 50-50 RHE

Size: 51 mm x 60 mm.
Material: PMMA.
Temperature: -40 to +70 °C.
Sealing Class: IP 67.

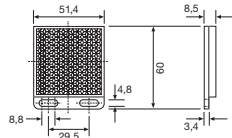

ILR 54-80 R

Size: 54 mm x 80 mm.
Material: PMMA.
Temperature: -40 to +70 °C.
Sealing Class: IP 67.

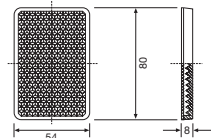

Circular Reflectors

ILR 82 CF

Size: Ø 82 mm.
Material: PMMA.
Temperature: -40 to +70 °C.
Sealing Class: IP 67.

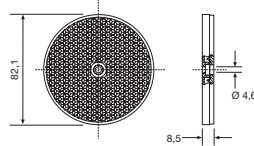

ILR 40 CF4

Size: Ø 40 mm.
Material: PMMA.
Temperature: -40 to +70 °C.
Sealing Class: IP 67.

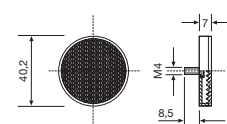

Telco reserves the right to change specifications without notice.

(Units in mm)

SOCKETS & CONNECTORS

TR 11
 Plug socket for PA
 photoelectric amplifiers
 and PP Power Packs.

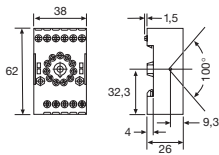

HFS
 Spring holder for
 TR 11 plug socket.

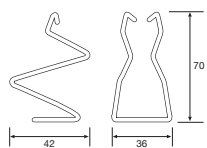

(Units in mm)

Bus Rail Connector 22.5
 Bus rail connector
 for PAB photoelectric
 amplifiers and
 PPB Power Pack.

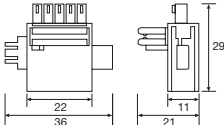

Telco reserves the right to change specifications without notice.

CABLES

Description

- Cables for photoelectric sensors and light curtains
- M8 or M12 connectors
- Straight or right angle connector design
- PUR or PVC sleeve material



Technical Data

		3-pin, M8	4-pin, M8	4-pin, M12	5-pin, M12
Rated voltage		60 V		250 V	125 V
Rated impulse voltage		800 V		2500 V	1500 V
Rated current		4 A			
Socket contacts		Bronze (gold plated)			
Connector material	Lock nut	Nickel-Plated Brass			
	Housing	PUR			
Temperature		-25 to +70 °C			
Sealing class	Snap-In	IP 65		-	
	Screw	IP 67		IP 68	

Cables								
Dimension Drawing (Units in mm)	Connector	Locking	Socket Design	Pins	Cable	Sleeve Material	5 m length	
							Order Reference	
	M8 x 1	Snap-In	Straight	3	3 x 0,25 mm ²	PVC	CAB K 3308 PVC S 5	
				4	4 x 0,25 mm ²	PUR	CAB K 3308 PUR S 5	
				3	3 x 0,25 mm ²	PVC	CAB K 4408 PVC S 5	
				4	4 x 0,25 mm ²	PUR	CAB K 4408 PUR S 5	
	M8 x 1	Snap-In	Right Angle	3	3 x 0,25 mm ²	PVC	CAB K 3308 PVC R 5	
				4	4 x 0,25 mm ²	PUR	CAB K 3308 PUR R 5	
				3	3 x 0,25 mm ²	PVC	CAB K 4408 PVC R 5	
				4	4 x 0,25 mm ²	PUR	CAB K 4408 PUR R 5	

	M8 x 1	Screw	Straight	3	3 x 0,25 mm ²	PVC	CAB KV 3308 PVC S 5	
				4	4 x 0,25 mm ²	PUR	CAB KV 3308 PUR S 5	
				3	3 x 0,25 mm ²	PVC	CAB KV 4408 PVC S 5	
				4	4 x 0,25 mm ²	PUR	CAB KV 4408 PUR S 5	
	M8 x 1	Screw	Right Angle	3	3 x 0,25 mm ²	PVC	CAB KV 3308 PVC R 5	
				4	4 x 0,25 mm ²	PUR	CAB KV 3308 PUR R 5	
				3	3 x 0,25 mm ²	PVC	CAB KV 4408 PVC R 5	
				4	4 x 0,25 mm ²	PUR	CAB KV 4408 PUR R 5	

	M12 x 1	Screw	Straight	4	4 x 0,25 mm ²	PVC	CAB KV 4412 PVC S 5	
				5	5 x 0,25 mm ²	PUR	CAB KV 4412 PUR S 5	
				4	4 x 0,25 mm ²	PVC	CAB KV 5512 PVC S 5	
				5	5 x 0,25 mm ²	PUR	CAB KV 5512 PUR S 5	
	M12 x 1	Screw	Right Angle	4	4 x 0,25 mm ²	PVC	CAB KV 4412 PVC R 5	
				5	5 x 0,25 mm ²	PUR	CAB KV 4412 PUR R 5	
				4	4 x 0,25 mm ²	PVC	CAB KV 5512 PVC R 5	
				5	5 x 0,25 mm ²	PUR	CAB KV 5512 PUR R 5	

Note: Special lengths and other models are available upon request.

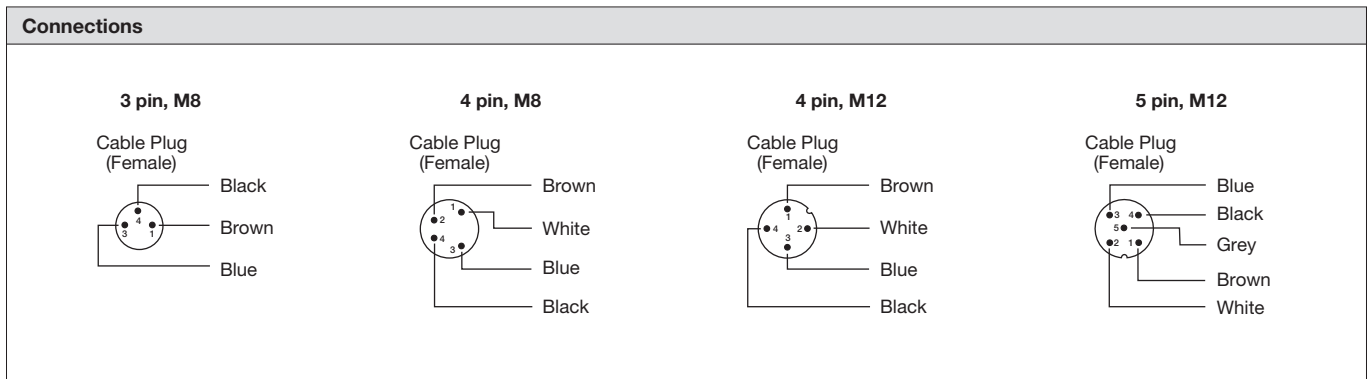

COMPLIMENTARY PRODUCTS

Optical Frame Sensor Series

OAS

- 50 mm to 250 mm frame width
- Aluminium housing
- Plug connection
- Infrared light source
- Sensitivity adjustment via potentiometer
- Pulse stretching adjustment via potentiometer
- Dynamic or static detection principle
- Output indicator
- High tolerance to hostile environments
- 24 V dc supply voltage
- 3 wire, PNP output
- Fast response time
- High resolution from 0,5 mm

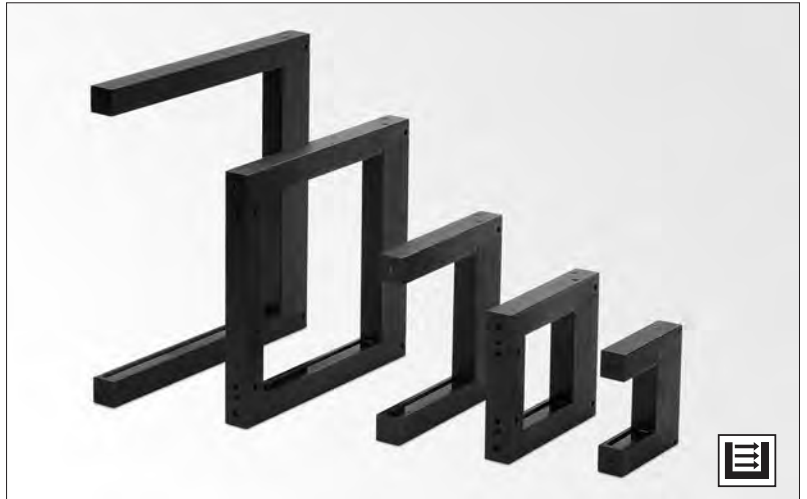

Please ask for your free literature or visit our website
www.telcosensors.com

APPLICATIONS

Remote Sensor Series

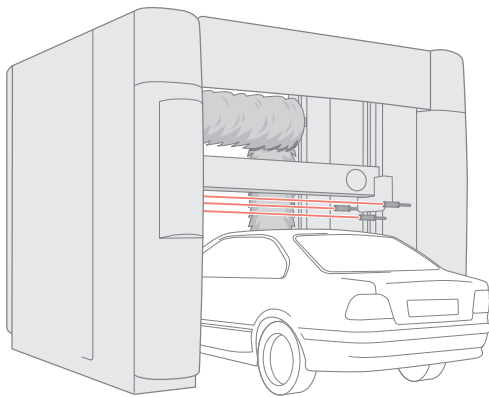

CARWASH
Vehicle contouring

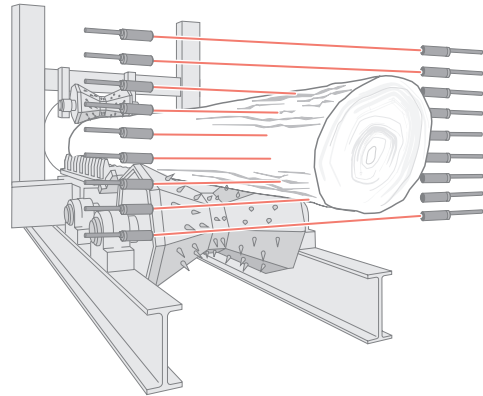

FORESTRY
Log measuring

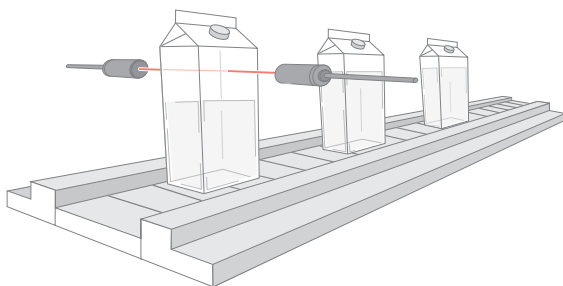

PACKAGING
Level control

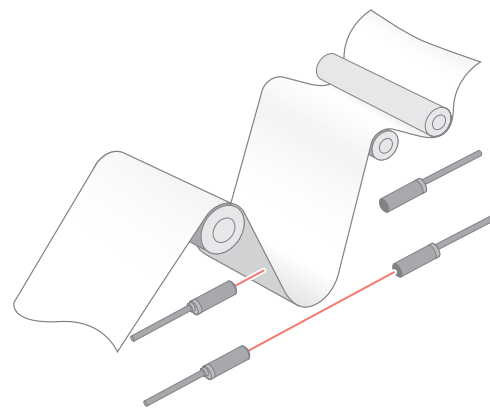

PAPER & PRINTING
Loop control



ESCALATOR
Pedestrian detection

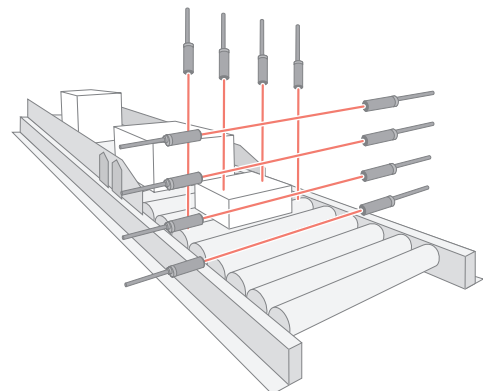

PACKAGING
Box sorting

APPLICATIONS

Remote Sensor Series

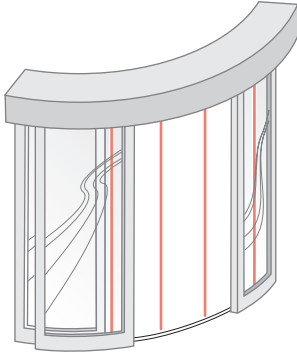

AUTOMATIC DOORS
Pedestrian detection

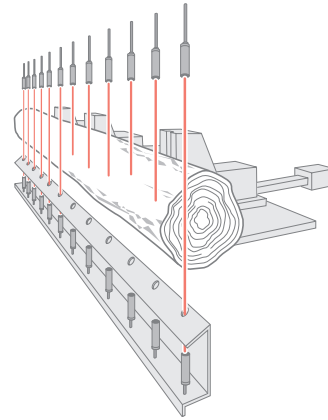

SAWMILL
Log positioning

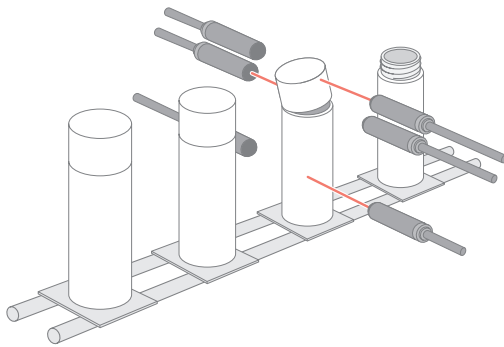

PACKAGING
Can cap inspection

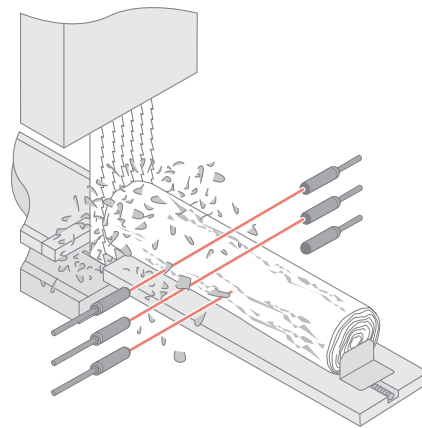

SAWMILL
Log profiling

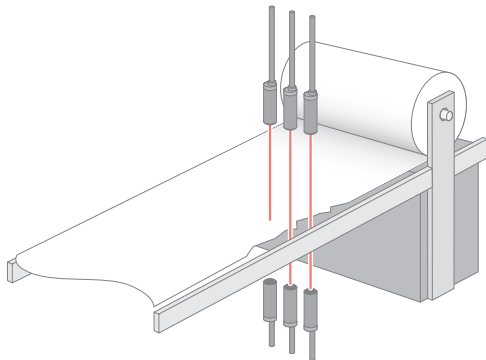

PAPER & PRINTING
Tear detection

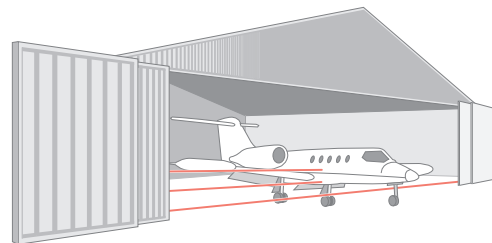

GATES
Plane and vehicle detection

SpaceMaster Series

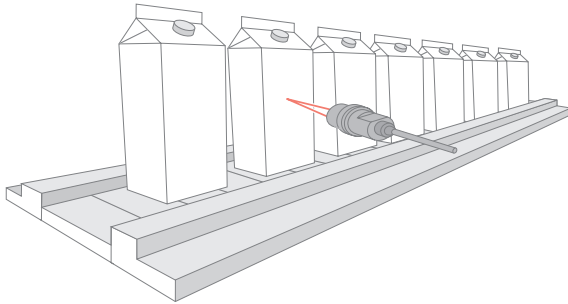

PACKAGING
Carton detection



ESCALATOR
Pedestrian detection

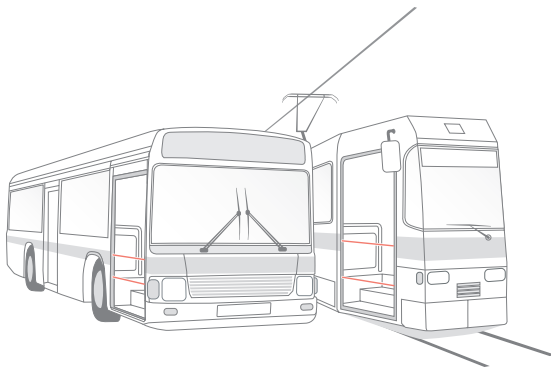

PUBLIC TRANSPORTATION
Pedestrian detection

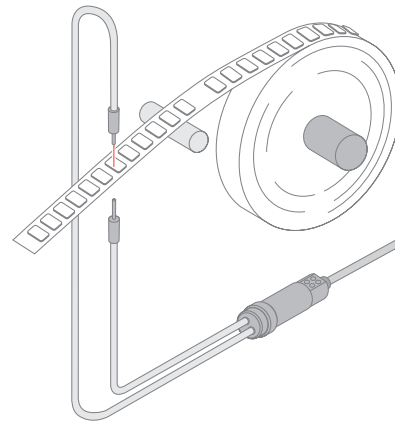

MANUFACTURING & ASSEMBLY
Component detection

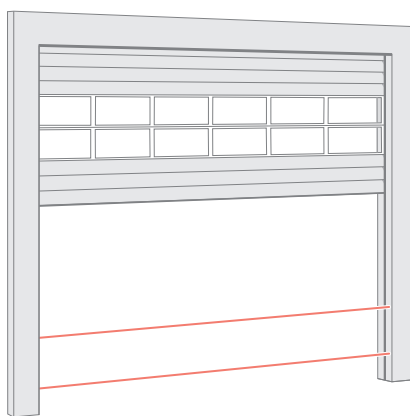

INDUSTRIAL DOOR
Vehicle and pedestrian detection

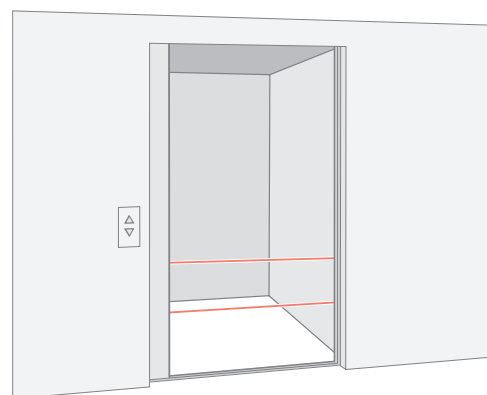

ELEVATOR
Pedestrian detection

APPLICATIONS

SpaceMaster Series

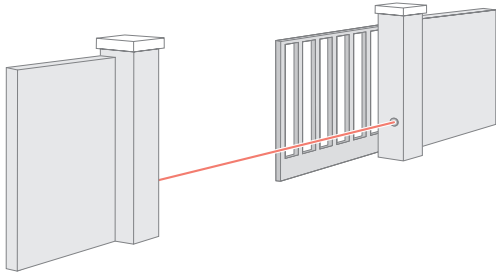

GATES
Vehicle and pedestrian detection

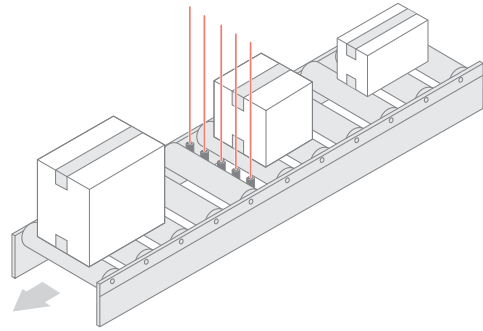

MATERIAL HANDLING
Box positioning

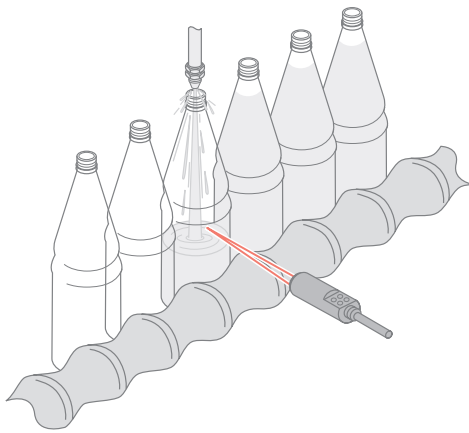

BOTTLING
Bottle positioning

SpacePak Series

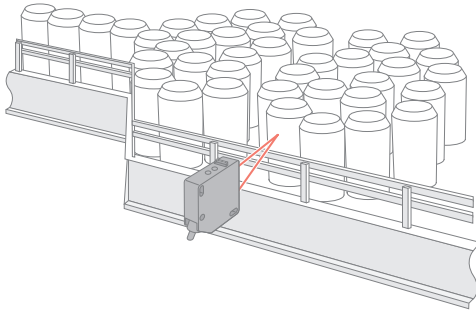

PACKAGING
Can flow control

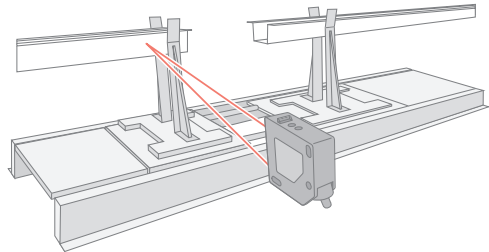

METAL & STEEL
Steel beam positioning

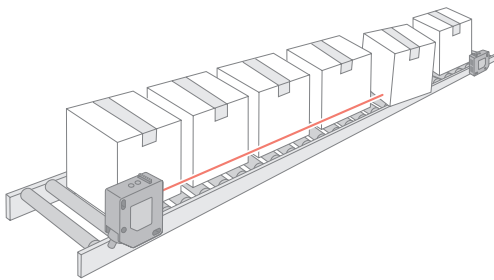

MATERIAL HANDLING
Box positioning

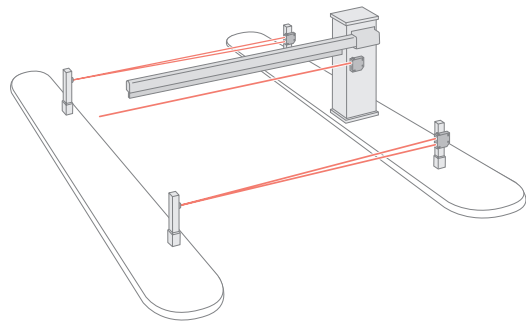

ACCESS CONTROL
Vehicle monitoring

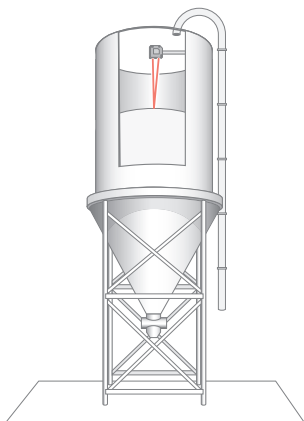

AGRICULTURE
Level control

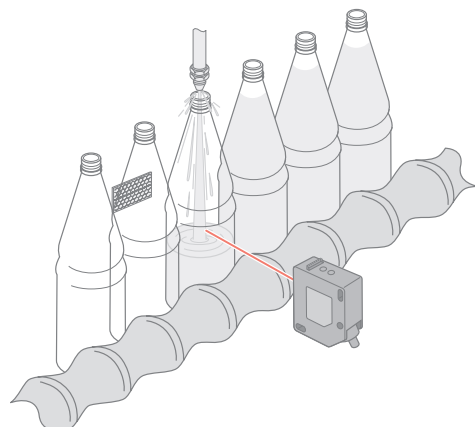

BOTTLING
Clear bottle detection

APPLICATIONS

SpacePak Series

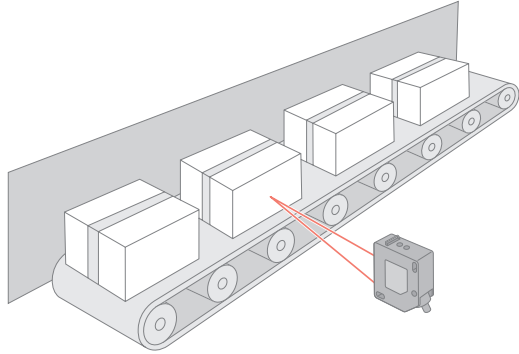

MATERIAL HANDLING
Box detection

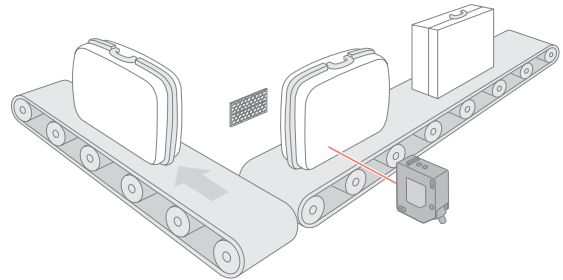

BAGGAGE HANDLING
Baggage detection

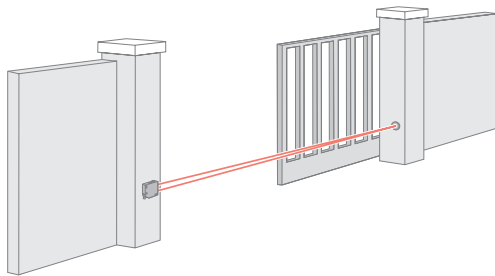

GATES
Vehicle and pedestrian detection

SpaceGuard Series

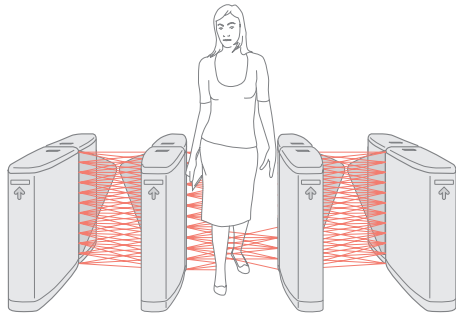

ACCESS CONTROL
Pedestrian detection

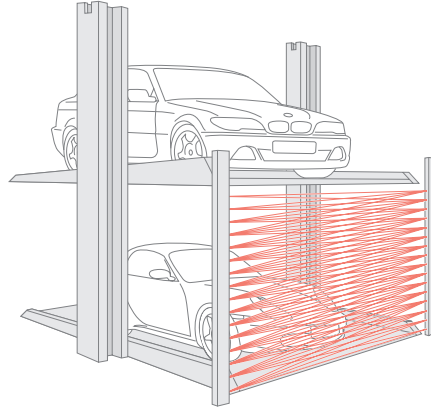

VEHICLE STACKING
Vehicle positioning

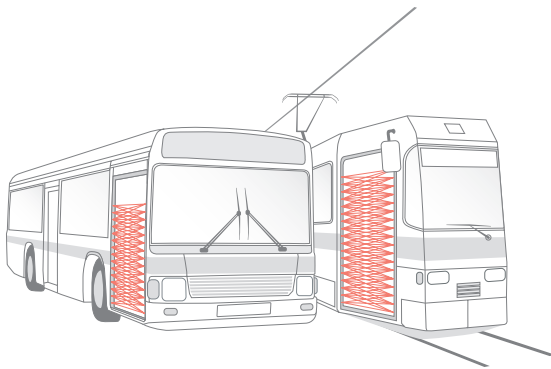

PUBLIC TRANSPORTATION
Pedestrian detection

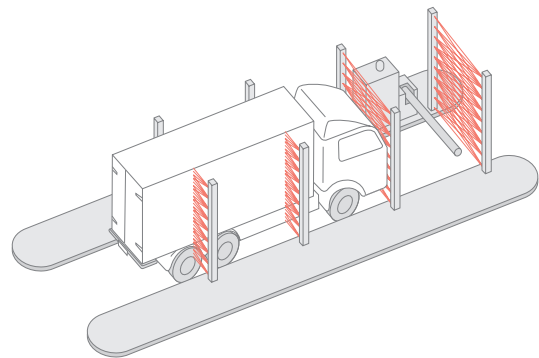

ACCESS CONTROL
Vehicle monitoring and verification

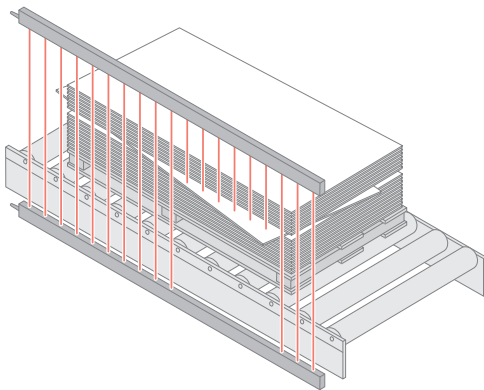

MATERIAL HANDLING
Protrusion detection

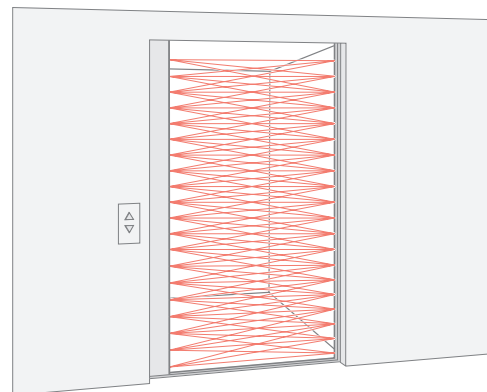

ELEVATOR
Pedestrian detection

APPLICATIONS

SpaceGuard Series

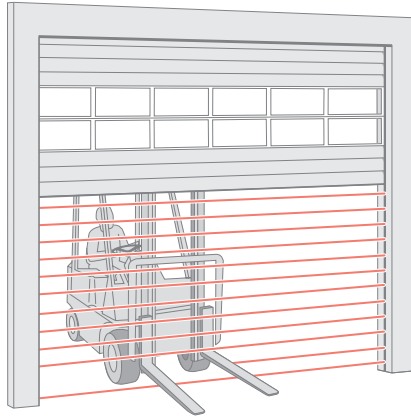

INDUSTRIAL DOOR
Vehicle and pedestrian detection

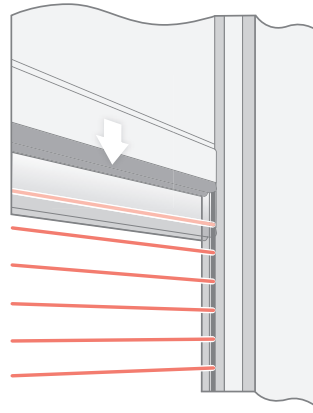

INDUSTRIAL DOOR
(CLOSE UP VIEW)

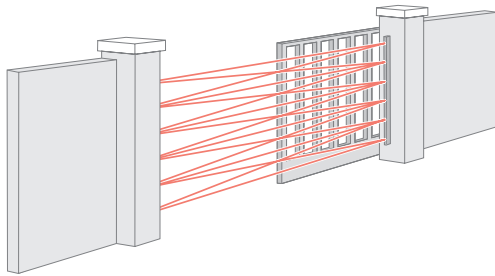

GATES
Vehicle and pedestrian detection

Optical Fork Sensors

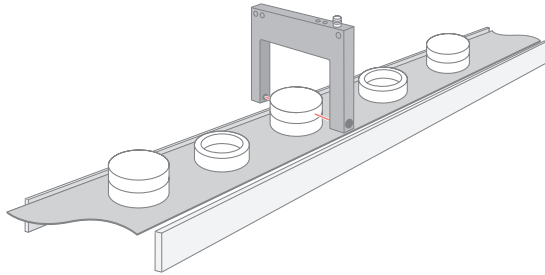

MANUFACTURING & ASSEMBLY
Lid inspection

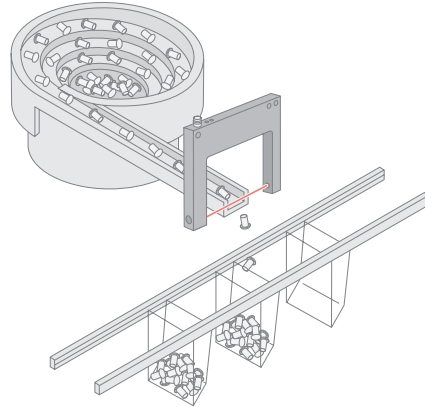

MANUFACTURING & ASSEMBLY
Parts count

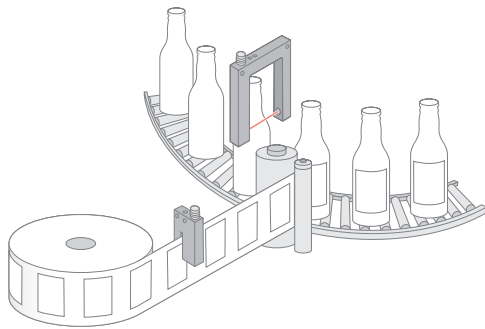

BOTTLING
Bottling and label monitoring

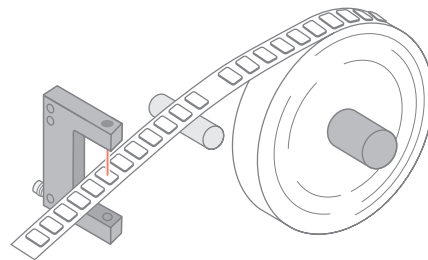

MANUFACTURING & ASSEMBLY
Component detection

GLOSSARY & REFERENCES

Aperture

An aperture, also known as a light shutter, is a mechanical piece mounted to restrict the size of a transmitter or receiver lens. Apertures are used to limit the amount of light received by a photoelectric receiver in thru-beam mode, thereby allowing reliable and precise detection of objects with the same profile as the opening.

Bifurcated Glass Fibre Optics

Bifurcated glass fibre optics are glass fibre optic cables that combine the transmitted and received light in the same cable assembly (via two branches consisting of different fibres), achieving diffuse proximity operation mode. An object is detected when the beam of light is reflected back to the receiving part of the cable.

Beam Spacing

Beam spacing is the distance between the centre of two adjacent channels in a light curtain detector rail. The channels consist of receiver elements in the receiver light curtain detector rail and transmitter diodes in the transmitter light curtain detector rail.

Control Input

Control input is a wire input used to control a sensor's transmitting power. The control input can also be used as a test input to test the function of a sensor system by switching off and on to check whether the output status changes.

Current Consumption

The maximum current consumption for a unit when used at a specified voltage supply or at the maximum rated supply voltage.

Dark Operated (DO)

Output is activated when no light is received from the transmitter. DO is an abbreviation for dark operated.

Electromechanical Relay

An electromechanical relay is a switching relay consisting of mechanical contacts, which is switched to an open or closed position by applying voltage to an electromagnetic coil.

Glass Fibre Optics

Transparent glass or plastic fibres used to conduct and guide light energy. Glass fibre optic assemblies consist of a bundle of small glass optical fibres housed in a flexible cable sheath. Glass fibre optics can withstand corrosive and high temperature environments, and enable detection in limited spaces. There are two models of glass fibre optic assemblies: bifurcated glass fibre optics and individual glass fibre optics.

Hysteresis

Hysteresis is the difference between the sensing distance of the switch on point when a target is moving towards the sensor and switch off point when the target is moving away from the sensor. The hysteresis is expressed as a percentage of the switch on point sensing distance.

IP Rating

IP is an abbreviation of "Ingress Protection" which is a classification system that designates, by a means of numbers, the degree of protection provided by an enclosure against penetration of solid objects and dust, and penetration of water. The rating system is established by IEC Publications 60529.

Individual Glass Fibre Optics

Individual glass fibre optics are glass fibre optic cables that are used in pairs and mounted opposite of each other so that the transmitting light is directed towards the receiving cable achieving thru-beam operation mode. An object is detected when the beam of light is interrupted between the transmitting and receiving cable.

Inductive Load Protection

Protection of a transistor output against voltage peaks occurring when an inductive load is switched off.

Light Operated (LO)

Output is activated when light is received from the transmitter. LO is an abbreviation for light operated.

Light Immunity

The light immunity of a sensor unit is the maximum ambient illuminance that can be tolerated without interfering with the input signal.

Minimum Cable Bending Radius

The minimum recommendable radius that a cable can be bent.

NPN

Transistor DC output with load connected to common positive supply (sinking).

Optical Cross Talk

Optical cross talk occurs when a photoelectric receiver responds to light from an adjacent transmitter. Cross talk can be resolved by re-positioning of the sensors or multiplexing of the sensors.

Optical Angle

The optical angle is a measure of the emission angle of the transmitter and the opening angle of the receiver. The emission angle is measured from the optical centre axis to 50% of the light intensity. The opening angle is measured from the optical centre axis to 50% of the sensitivity. The optical angle is expressed as +/- angle.

Opto Isolated Output

Opto isolated output is an output circuit that is separated from the main electronics via an optical switch IC.

Operation Frequency

Operation frequency is the measure of the speed at which a sensor can trigger. The frequency is measured by the number of times that a sensor can trigger per second. The operation frequency is expressed as hertz (Hz).

On Delay

On delay is a timing logic in which timing begins at the start point of an input signal. An output is only activated if the input signal is continuous for the pre-set on delay time period. If the input signal is not continuous for the pre-set on delay time period, no output is activated.

Off Delay

Off delay is a timing logic in which timing begins after the finish point of an input signal. An output is activated and remains activated for the pre-set off delay time period.

GLOSSARY OF TERMS

PNP

Transistor DC output with load connected to common negative supply (sourcing).

Retro Reflectors

A retro reflector is a reflective target used in retro-reflective operation mode to reflect the transmitter light back to the receiver.

Response Time

Response time is the time delay between the input signal and output trigger. The response time is expressed as milliseconds (ms).

Sensing Range

The sensing ranges of photoelectric sensors are measured differently according to the operation modes of the sensors.

- **Thru-beam:** measured with transmitter and receiver sensors aligned directly opposite of each other.
- **Diffuse Proximity:** measured against white matt A4 size paper.
- **Background Suppression:** measured against white matt A4 size paper.
- **Retro Reflective:** measured against circular retro reflector with 82 mm diameter (Telco retro reflector type: ILR 82 CF)
- **Polarised Retro Reflective:** measured against circular retro reflector with 82 mm diameter (Telco retro reflector type: ILR 82 CF)
- **Glass Fibre Sensor:** dependent of length, light conductive material and operation mode of glass fibre optic cables.
- **Light Curtains:** measured with transmitter and receiver sensors aligned directly opposite of each other.

Test Input

Test input is a wire input used to test the function of a sensor system by switching off and on to check whether the output status changes.

Time-Out

Time-out is a timing logic (in light curtain systems) that allows one or more light beams if interrupted (or failed) for more than a pre-set time period, to be ignored and resume operation with the remaining light beams. If the timed-out light beams resume operation, the time-out function will automatically be cancelled.

Transistor Output

A transistor output is a solid state switch used in DC voltage sensors for switching the negative potential (NPN) or positive potential (PNP).

Voltage Ripple

Voltage ripple (100 to 120 Hz) is a variation of the voltage supply. The voltage ripple is expressed as percentage of the nominal supply voltage.



Thru-beam

Thru-beam requires a separate transmitter and receiver sensor that are mounted and aligned opposite of each other so that the transmitter directs its light towards the receiver. An object is detected when the beam of light is interrupted between the transmitter and receiver sensors. Thru-beam is the most effective use of infrared light enabling the highest level of excess gain for reliable sensing through contaminated environments.



Diffuse Proximity

Diffuse Proximity requires a transmitter and receiver that are mounted adjacent to each other, in the same or separate housing, so that the transmitter directs its light towards the object to be detected. An object is detected when the beam of light is reflected back to the receiver. The sensing range is dependent of the reflectivity of the object.



Background Suppression

Background suppression requires a transmitter and receiver that are mounted adjacent to each other, in the same housing, so that the transmitter directs its light towards the object to be detected. An object is detected when the beam of light is reflected back by an object, within the defined detection area, back to the receiver. The object is detected independently of the reflectivity of its surface, which ensures that the background can remain undetected.



Retro Reflective

Retro Reflective requires a transmitter and receiver that are mounted adjacent to each other, in the same housing, so that the transmitter directs its light towards a retro reflector mounted opposite that reflects light back to the receiver. An object is detected when the beam of light is interrupted between the sensor and retro reflector.



Polarised Retro Reflective

Polarised retro reflective requires a transmitter and receiver that are mounted adjacent to each other, in the same housing, so that the transmitter directs its light towards a retro reflector mounted opposite that reflects light back to the receiver. An object is detected when the beam of light is interrupted between the sensor and retro reflector. Special polarising filters ensure that the receiver only senses light reflected by a retro reflector, which ensures that shiny and reflective objects are reliably detected.



Light Curtains

Light curtain systems require a separate transmitter and receiver detector that are mounted and aligned opposite of each other so that multiple light beams are established between the detectors. An object is detected when one or more light beams are interrupted between the transmitter and receiver detectors.



Fork Sensors

Fork sensor requires a transmitter and receiver that are mounted in a fixed position, opposite of each other in the same housing, so that the transmitter directs its light towards the receiver. An object is detected when the beam of light is interrupted between the transmitter and receiver.



Fibre Sensor Individual Fibre Optics

Fibre sensor requires a transmitter and receiver, in the same or separate housing, to which glass fibre optic cables are individually connected to conduct and guide light from the transmitter and to the receiver. Individual fibre optic cables are used in pairs and mounted opposite of each other so that the transmitting light is directed towards the receiving cable achieving thru-beam operation mode. An object is detected when the beam of light is interrupted between the transmitting and receiving cable. Glass fibre optics are able to withstand corrosive and high temperature environments, and enable detection in limited space.



Fibre Sensor Bifurcated Fibre Optics

Fibre sensor requires a transmitter and receiver, in the same or separate housing, to which a glass fibre optic cable is connected to conduct and guide light from the transmitter and to the receiver. Bifurcated fibre optic cables combine the transmitted and received light in the same cable assembly (via two branches consisting of different fibres) achieving diffuse proximity operation mode. An object is detected when the beam of light is reflected back to the receiving part of the cable. Glass fibre optics are able to withstand corrosive and high temperature environments, and enable detection in limited space.



Frame Sensors

Frame sensor requires a transmitter and receiver that are mounted in a fixed position, opposite of each other in the same housing, so that the transmitted light array of multiple beams are directed towards the receiver. An object is detected when one or more of the multiple light beams are interrupted between the transmitters and receivers.

REFERENCE TABLES

IP Ingress Protection Rating

1st Characteristic – Protection against ingress of solid objects		2nd Characteristic – Protection against ingress of water	
Numeral	Description	Numeral	Description
0	No protection	0	No protection
1	Protected against solid objects larger than 50 mm	1	Protected against vertically falling water drops
2	Protected against solid objects larger than 12.5 mm	2	Protected against vertically falling water drops when enclosure tilted up to 15 °
3	Protected against solid objects larger than 2.5 mm	3	Protected against spraying water
4	Protected against solid objects larger than 1.0 mm	4	Protected against splashing water
5	Protected against dust	5	Protected against water jets
6	Dust tight	6	Protected against powerful water jets
		7	Protected against the effects of temporary immersion in water

Relative Reflectivity of Materials

Material	Relative Reflectivity
Stainless steel, micro finish*	500 %
Natural aluminium, unfinished*	175 %
Stainless steel, brushed	150 %
Black anodized aluminium*	144 %
Opaque white plastic*	110 %
White paper	100 %
Dimension lumber (pine, dry, clean)	94 %
Beer foam	88 %
Kraft paper cardboard	88 %
Newspaper with print	69 %
Tissue paper, 2 ply	60 %
Clear plastic*	50 %
Tissue paper, 1 ply	44 %
Rough wood pallet (clean)	25 %
Opaque black plastic*	17 %
Black neoprene	5 %
Black rubber tyre wall	2 %

Note: Shiny materials marked with *, the reflectivity value represents the maximum light return with the sensor beam exactly perpendicular to the material surface.

Unit Measurements

Unit	Symbol	Measurement
Volt AC	V ac	Electrical potential – alternating current
Ampere	A	Electrical current
Volt DC	V dc	Electrical potential – direct current
Degrees Celsius	° C	Temperature
Hertz	Hz	Frequency (cycles per second)
Lux	lux	Illumination (lm/m ²)
Metre	m	Length
Microsecond	µs	Time (10 ⁻⁶ s)
Milliampere	mA	Electrical current (10 ⁻³ A)
Millimetre	mm	Length (10 ⁻³ m)
Millisecond	ms	Time (10 ⁻³ s)
Nanometer	nm	Length (10 ⁻⁹ m)
Second	s	Time
Volt	V	Electrical potential
Volt Ampere	VA	Power
Watt	W	Power

GLOBAL NETWORK

Argentina	Lithuania
Australia	Malaysia
Austria	Mexico
Belgium	Morocco
Brazil	Netherlands
Canada	New Zealand
Chile	Norway
China	Peru
Colombia	Philippines
Croatia	Poland
Czech Republic	Portugal
Denmark	Republic of Ireland
Estonia	Russia
Finland	Singapore
France	Slovakia
Germany	Slovenia
Greece	South Africa
Hong Kong	Spain
Hungary	Sweden
India	Switzerland
Indonesia	Taiwan
Israel	Thailand
Italy	Turkey
Japan	Ukraine
Korea	United Kingdom
Kuwait	USA
Latvia	Venezuela

INTERNATIONAL SALES & MARKETING

Telco Sensors S.L.
Edificio Marina Marbella 7B
Ctra. de Cadiz km 182.5
29603 Marbella, Spain
Tel: Int +34 952 765031
Fax: Int +34 952 823211
E-mail: info@telcosensors.com

PRODUCTION

Telco Electronics A/S
Vangen 5
DK-9460 Brovst
Denmark
Tel: Int +45 9823 3800
Fax: Int +45 9823 3838
E-mail: info@telcoelectronics.dk

RESEARCH & DEVELOPMENT

Telco A/S
Scion DTU
Diplomvej Bygning 373 S 1
DK-2800 Kgs. Lyngby
Denmark
Tel: Int +45 5650 3300
Fax: Int +45 5650 4018
E-mail: info@telco.dk

HEAD OFFICE USA & CANADA

Telco Sensors Inc.
1456 Center Park Drive
Charlotte, N.C. 28217
Tel: Int +1 704 357 9393
Fax: Int +1 704 357 9373
Toll Free: 800 253 0111
E-mail: info@telcosensorsusa.com

HEAD OFFICE POLAND

Telco Poland Sp. z o.o.
Ul. Makowa 8
PL 61-464 Poznań
Tel: Int +48 61 8303 853
Fax: Int +48 61 8303 614
E-mail: biuro@telcosensors.com.pl

Members of the Telco Group of Companies

For more information please visit our website
www.telcosensors.com

